



RESIDENTIAL VENTILATION 

CATALOGUE



INDEX

05	LEGEND	54	VORTEX® RANGE Cooker hoods
06	PUNTO RANGE Wall/window axial fans	58	ARIETT RANGE Centrifugal duct fans
12	PUNTO FILO RANGE Wall axial fans	62	ARIETT HABITAT RANGE Centrifugal duct fans
16	PUNTO FOUR RANGE Wall axial fans	64	ARIETT I RANGE Centrifugal duct fans for flush mounting
20	PUNTO GHOST RANGE In-line axial fans	70	VORT PRESS RANGE Centrifugal duct fans
24	PUNTO EVO FLEXO RANGE Wall axial fans	74	VORT PRESS HABITAT RANGE Centrifugal duct fans
28	PUNTO EVO RANGE Wall axial fans	78	VORT PRESS I RANGE Centrifugal duct fans for flush mounting
34	PUNTO EVO ES RANGE Wall axial fans energy savings	82	VORT QUADRO RANGE Centrifugal duct fans
38	PUNTO EVO GOLD RANGE Wall axial fans	88	VORT QUADRO I RANGE Centrifugal duct fans for flush mounting
42	VORTICE VARIO RANGE Wall/window axial fans	94	VORT QUADRO EVO RANGE Residential centrifugal extractor fans
46	VORTICE VARIO I RANGE Flush mounted axial fans	106	VORT NOTUS RANGE De-centralised continuous axial fans
50	K RANGE In-line centrifugal fans for kitchen cabinet	110	RESIDENTIAL VENTILATION ACCESSORIES

CE MARKING

Residential Ventilation products comply with the following European Directives:

2006/95/EC Low Voltage Directive (LVD)
2004/108/EC Electromagnetic Compatibility Directive (EMC)

According to the following state-of-the-art Standards:

Safety

EN 60335-1, EN 60335-2-80, EN 60335-2-40, EN 622233

Electromagnetic Compatibility

EN 55014-1; EN 55014-2; EN 61000-3-2; EN 61000-3-3



air is life

We work to promote life quality
and to contribute to the social evolution
through eco-friendly products
that move air **safely and efficiency.**



vortice.com



LEGEND



SILENT RUNNING AND CERTIFIED, GUARANTEED PERFORMANCE

IMQ PERFORMANCE is an independent quality mark which certifies, according to international standards, performances (air flow and pressure) and noise levels of the product.



SAFE

Safety, power rating, enclosure protection rating (IP44 to EN 60529) and electrical insulation are certified by IMQ (Quality Mark Institute), the Italian national certifying agency. The IMQ mark certifies that the product is manufactured in compliance with the provisions of relevant established safety standards and directives: (EN 60335-1, EN 60335-2-80 and EN 62333) Low Voltage Directive (LVD) and Electromagnetic Compatibility Directive (EMC). IMQ also guarantees regular, constant monitoring of production quality.



ENERGY SAVING

ES label means that the appliance is fitted with EC Brushless motor and provides high energy savings, thanks to a wide range of speed regulation options and very low consumption levels.



ERP COMPLIANT

The ErP compliant logo indicates that the appliance is eco-compatible and adheres to the ErP directive 2009/125/CE.



LONG LIFE 30.000 H

The Long Life 30,000 h label certifies that the appliance is guaranteed to continuously run at max operating temperature for 30,000 hours without mechanical failure thanks to its motor, equipped with ball bearings.



STANDARD

All models are manufactured with shielded poles and have bronze bearings for a long life



AUTOMATIC

The integral shutters positioned behind the front grille automatically open and close slowly when the unit is operated. The shutters are made from shockproof, anti-UV-treated, plastic.



TIMER

The timer comes on when the light is switched on. When the light is turned off, the unit continues to operate for 3 to 20 minutes, depending on the timer setting.



PIR

The unit turns on a few seconds after the person has entered the room (sensor is located in an inclined position to increase sensitivity), and continues to operate during the person's presence. When the person leaves the room, the unit will continue to run from between 3 to 20 minutes depending on the timer setting.



T-HCS

The appliance features a relative humidity sensor that is factory set at 60%. When relative humidity exceeds that level, the appliance automatically starts up. This threshold setting can however be modified by the installer to 4 levels: 60%, 70%, 80%, and 90%. The unit turns off when the RH drops back to 60% and when the light is switched off, the unit continues to run between 3 to 20 minutes depending on the timer setting.



12 V

A power supply unit is needed wherever the use of low-voltage equipment is required. The two available low-voltage fans - one with and one without automatic shutter - can be used in combination with any of the power supply units.



PULLCORD

The unit is switched on by pulling the insulated pull cord.



Design: F. Trabucco & Associates



PUNTO RANGE

Wall/window axial fans **LONG LIFE 30.000h**

For intermittent or continuous ventilation of bathrooms, toilets, kitchens or utility rooms in domestic or commercial properties.

- **53 models:** from Ø 100 to 150 available with or without the option of automatic shutters, timer, pull cord, humidistat, electronic microprocessor and Passive infrared.
- Motor with shielded poles, either with bronze or ball bearings, and with thermal cut-out.
- Motor support and grille made of anti-UV ABS.
- High airflow rate, low operating noise level and low power consumption due to the wing profile blades and motor support.
- The standard models can be speed regulated.
- Protection rating: IPX4.
- Insulation class: II

Punto 12V.

- **8 models:** available with or without automatic shutters;
In the automatic version the shutters positioned behind the front grille automatically open and close slowly when the unit is operated.
- The shutters are made from shockproof, anti-UV-treated plastic.
- 12V motor with shielded poles, bronze bearings and thermal cut-out.
- Insulation: Selv CI.III.

Punto PIR

- **12 models:** The unit turns on a few seconds after the person has entered the room (sensor is located in an inclined position to increase sensitivity), and continues to operate during the person's presence. When the person leaves the room, the unit will continue to run from between 3 to 20 minutes depending on the timer setting.

Punto T-HCS.

- **3 models:** adjustable RH threshold at 60%, 70%, 80%, 90% by mean of a slide switch during installation.
- Smart working mode: the product automatically switches on when the indoor relative humidity level exceeds the pre-set value. A timer automatically switches off the product when the relative humidity decreases under the pre-set limit.



RANGE

Diam.	BASIC	TIMER	PIR	BASE AUTOMATIC	TIMER AUTOMATIC	PIR AUTOMATIC
Ø100	11201 M 100/4" 11641 M 100/4" P	11211 M 100/4" T	11681 M 100/4" PIR	11221 M 100/4" A 11646 M 100/4" AP	11231 M 100/4" AT	11683 M 100/4" A PIR
Ø120	11301 M 120/5" 11741 M 120/5" P	11311 M 120/5" T	11781 M 120/5" PIR	11321 M 120/5" A 11746 M 120/5" AP	11331 M 120/5" AT	11783 M 120/5" A PIR
Ø150	11401 M 150/6" 11851 M 150/6" P	11411 M 150/6" T	11881 M 150/6" PIR	11421 M 150/6" A 11856 M 150/6" AP	11431 M 150/6" AT	11883 M 150/6" A PIR

Diam.	BASIC LONG LIFE	TIMER LONG LIFE	PIR LONG LIFE	LONG LIFE AUTOMATIC	TIMER AUTOMATIC LONG LIFE	PIR AUTOMATIC LONG LIFE	TIMER AUTOMATIC HCS LONG LIFE
Ø100	11202 M 100/4" LL	11212 M 100/4" T LL	11682 M 100/4" PIR LL	11222 M 100/4" A LL	11232 M 100/4" AT LL	11684 M 100/4" A PIR LL	11616 M 100/4" AT HCS LL
Ø120	11302 M 120/5" LL	11312 M 120/5" T LL	11782 M 120/5" PIR LL	11322 M 120/5" A LL	11332 M 120/5" AT LL	11784 M 120/5" A PIR LL	11692 M 120/5" AT HCS LL
Ø150	11402 M 150/6" LL	11412 M 150/6" T LL	11882 M 150/6" PIR LL	11422 M 150/6" A LL	11432 M 150/6" AT LL	11884 M 150/6" A PIR LL	11698 M 150/6" AT HCS LL

Diam.	BASIC 12 V	TIMER 12V	BASE AUTOMATIC 12 V	TIMER AUTOMATIC 12V
Ø100	11203 M 100/4" 12V 22150 GA 12V	11203 M 100/4" 12V 22150 GA 12V T	11223 M 100/4" A 12V 22150 GA 12V	11223 M 100/4" A 12V 22151 GA 12V T

TECHNICAL DATA

MODELS	V~50HZ	W max	A max	RPM max	MAX AIRFLOW		MAX PRESSURE		Lp dB(A) 3m max	MAX °C	KG
					m³/h	l/s	mmH ₂ O	Pa			
M 100/4"	220-240	18	0.10	2300	90	25	3	29	37.5	50	0.60
M 120/5"	220-240	20	0.12	2100	175	48.6	4.5	44	39.5	50	0.80
M 150/6"	220-240	30	0.15	2100	335	93.1	6	59	46.0	50	1.10



RESIDENTIAL VENTILATION

PUNTO RANGE

PUNTO RANGE | TECHNICAL DATA FOR REGULATION N° 1254/2014/UE

	UNIT OF MEASURE	M 90/3.5"	M 100/4"	M 120/5"	M 150/6"
Supplier's name or trade mark	-	Vortice	Vortice	Vortice	Vortice
Specific Energy Consumption class SEC in average climate zone	-	NA*	NA*	NA*	NA*
Specific Energy Consumption class SEC average	-	-4.1	-6.6	-8.0	-9.7
Specific Energy Consumption class SEC cold	kWh/m ² year	-17.5	-20.0	-21.3	-23.0
Specific Energy Consumption class SEC warm	-	3.5	1.0	-0.3	-20
Declared typology	-	RVU-U*	RVU-U*	RVU-U*	RVU-U*
Type of drive	-	NA	NA	NA	NA
Type of heat recovery system HRS	-	none	none	none	none
Thermal efficiency of heat recovery at reference air flow	%	NA*	NA*	NA*	NA*
Maximum flow rate	m ³ /h	67	89	164	324
Electric power input of the fan drive, including any motor control equipment, at maximum flow rate	W	13.3	13.7	20.6	27.8
Sound power level LWA	LWA [DB(A)]	60	58	60	67
Reference flow rate	m ³ /s	0.0129	0.173	0.0319	0.630
Reference pressure difference	Pa	20	15	20	28
SPI	W/(m ³ /h)	0.28571	0.21348	0.17422	0.12434
Control factor CTRL	-	1	1	1	1
Control typology	-	manual	manual	manual	manual
Maximum internal leakage rates	%	NA	NA	NA	NA
Maximum external leakage rates	%	NA	NA	NA	NA
Mixing rate	-	NA	NA	NA	NA
Position and description of visual filter warning	-	NA	NA	NA	NA
Airflow sensitivity to pressure variations at + 20 Pa and - 20 Pa	-	NA	NA	NA	NA
Indoor/outdoor air tightness	m ³ /h	NA	NA	NA	NA
Annual electricity consumption (AEC)	kWh electricity/year	394	294	240	171
AHS average Annual heating saved	-	1397	1397	1397	1397
AHS cold Annual heating saved	kWh primary energy/year	2732	2732	2732	2732
AHS warm Annual heating saved	-	632	632	632	632

* RVU-U: Unit Ventilation Residential - Unidirectional

** NRUVU-U: Unit Ventilation Non Residential - Unidirectional

*** MSD: Multi-Speed Drive

NA: Not applicable



DIMENSIONS

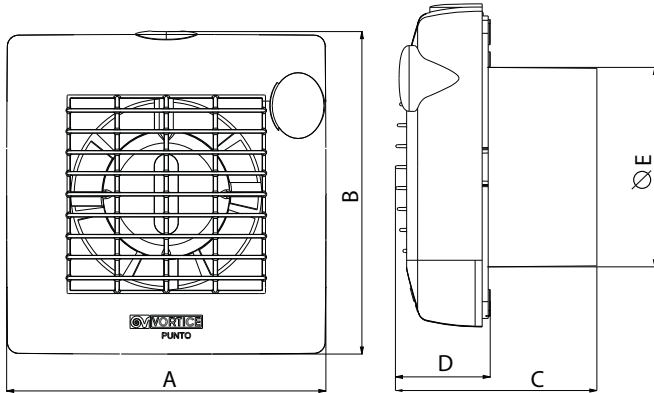

MODELS	A	B	C	D	∅E
M 100/4"	159	160	100	47	99
M 120/5"	179	181	110	47	119
M 150/6"	214	215	117	47	156

Dimensions (mm)

PERFORMANCE CURVES

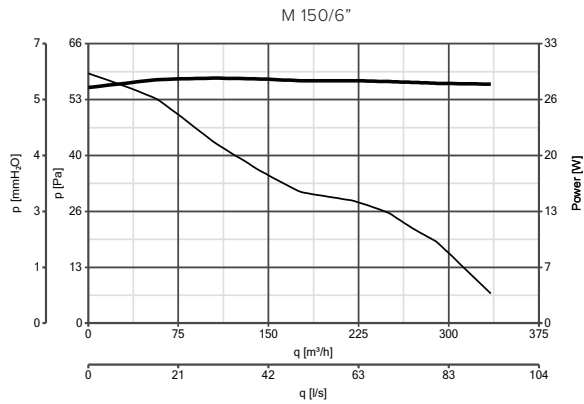
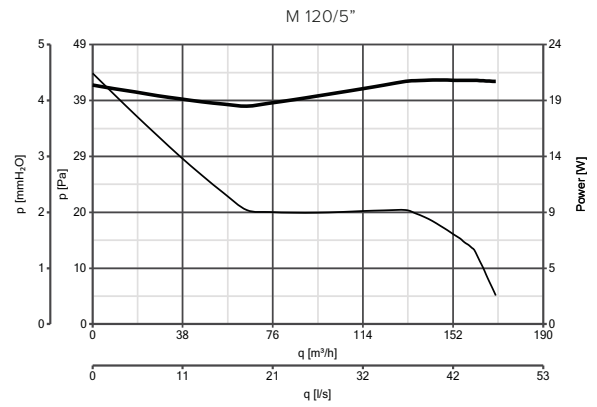
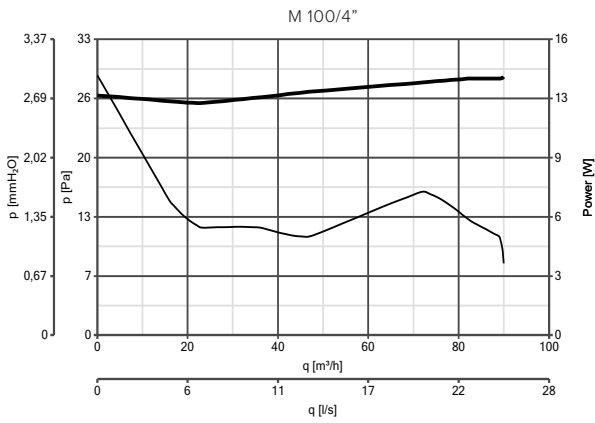

Power consumption
 Delivery





RESIDENTIAL VENTILATION

PUNTO RANGE

CONTROLLER

MODELS	DESCRIPTION	CODE	PRODUCT
	IREM 30 - Single phase speed controller	12912	All products
	C 1.5 - Electronic speed controller 1.5 A	12966	11201- 11202 - 11222 - 11301 - 11302 11321 - 11322 - 11401 - 11402 - 11421 - 11422
	SCNRB - Electronic speed controller built-in	12971	11201- 11202 - 11221 - 11222 - 11301 11302 - 11321 - 11322 - 11401 - 11402 - 11421 11422
	SCB KIT - Built-in controller adaptor for C 1.5	22481	12966

ACCESSORIES ON REQUEST

MODELS	DESCRIPTION	CODE	PRODUCT
	F KIT - Kit to window-mount	100/4"	11201 - 11202 - 11203 - 11211 - 11212 - 11681 11682 - 11221 - 11222 - 11223 - 11231 11232 - 11683 - 11684 - 11616
		120/5"	11301 - 11302 - 11311 - 11312 - 11781 - 11782 11783 - 11321 - 11322 - 11331 - 11332 11784 - 11692
		150/6"	11401 - 11402 - 11411 - 11412 - 11881 - 11882 11421 - 11422 - 11431 - 11432 - 11883 11884 - 11698
	S KIT - Ceiling kit	100/4"	11201 - 11202 - 11203 - 11211 11212 - 11681 - 11682 - 11221 - 11222 - 11223 11231 - 11232 11683 - 11684 - 11616
		120/5"	11301 - 11302 - 11311 - 11312 - 11781 - 11782 11783 - 11321 - 11322 - 11331 - 11332 - 11784 11692
		150/6"	11401 - 11402 - 11411 - 11412 - 11881 - 11882 11421 - 11422 - 11431 - 11432 - 11883 11884 - 11698
	GA	12V	11203 - 11223
		12V T	11203 - 11223

F KIT - KIT TO WINDOW-MOUNT TECHNICAL DATA AND DIMENSIONS OF THE "PRODUCT+KIT".

MODELS	KIT	CODE	W	A	RPM	MAX AIRFLOW		LP DB(A) 3m	MAX °C	KG
						m³/h	l/s			
M 100/4"	F 100/4"	22131	18	0.10	2300	85	23.6	38	50	0.85
M 120/5"	F 120/5"	22132	20	0.12	2000	140	38.9	40.5	50	1.15
M 150/6"	F 150/6"	22133	30	0.15	1950	280	77.8	44.5	50	1.56

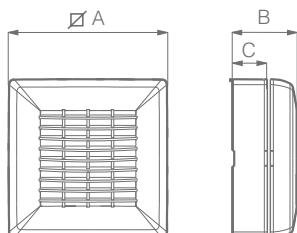

MODELS	Ø A	B	C	Ø GLASS HOLE	THICKNESS
M 100/4"	158	69	22	123 ÷ 128	20
M 120/5"	179	80	33	143 ÷ 148	20
M 150/6"	213	87	40	178 ÷ 183	20

Dimensions (mm)



APPLICATIONS





Design: F. Trabucco & Associates



PUNTO FILO RANGE

Wall axial fans **LONG LIFE 30.000 h**

Wall, ceiling and false-ceiling axial fans, characterised by very low thickness to better blend into rooms, ideal for ventilation in small and medium-size residential and commercial premises whose layout allows for direct exhaust or exhaust in short length pipes.

Key features

- Reduced exhaust sleeve depth, compatible with installation immediately upstream of a 90° bend.
- Reduced thickness (17 mm for all models) which minimises the aesthetic impact of the installed product.
- High protection from water, suitable for use in Zone 1 bathroom installations and in the presence of high relative humidity.
- Elegant design (the PUNTO FILO design took home the International "INTEL DESIGN 2005" award).
- Extremely reliable and low maintenance: the ball bearing motors of the LL models guarantee regular continuous operation for at least 30,000 h at the maximum plate temperature.

Version

21 models, with nominal diameter between 90 and 150 mm, available in versions driven by bushing and bearing motors and in timer versions, with a humidity sensor and a presence sensor.

Technical features

- White, shock-proof, plastic resin (ABS) panels, prevents ageing caused by exposure to sunlight ("UV resistant").
- Shaded pole motors, heat protected, with shafts mounted on bushings with self centring and self-lubricating neck to favour low sound emissions, or on ball bearings (LL models) to ensure long lasting (at least 30,000 h) continuous service at the maximum plate temperature. Speed adjustment using Vortice accessory devices.
- Axial impellers with airfoil shaped blades to combine high performance with low noise emissions.
- Non-return valves on the delivery spigots to prevent unwanted inflows of air and bad odours when the device is switched off.
- T models equipped with electronic timer for automatic product switch-off after a pre-fixed period of time, which can be set in the installation phase, from 3'-20' (default setting 3').
- T-HCS models equipped with circuit board with relative humidity sensor (RH), adjustable to 4 predefined threshold levels (60%, 70%, 80%, 90 %), alternatively can be set during installation, which determines automatic fan activation. The board integrates an electronic timer for automatic shut-down of the product after return to a RH below the pre-set threshold. The duration of the timer can be set at installation within the interval 3'-20' (default setting 3').
- PIR models equipped with an IR presence sensor which determines automatic fan activation in the presence of occupants in the serviced room. The board integrates an electronic timer for automatic shut-down of the product after the occupants have left the premises. The duration of the timer can be set at installation within the interval 3'-20' (default setting 3').
- Performance and safety certified by third party body (IMQ)
- Protection rating from dust and water: IPX4.
- Class of electric isolation: II □ (earthing not required).



RANGE

Diam.	BASIC	TIMER	LONG LIFE	TIMER LONG LIFE	TIMER HCS LONG LIFE	PIR LONG LIFE
Ø90	11122 MF 90/3.5"	11126 MF 90/3.5" T	-	-	11138 MF 90/3.5" THCS LL	-
Ø100	11123 MF 100/4"	11127 MF 100/4" T	11131 MF 100/4" LL	11135 MF 100/4" T LL	11139 MF 100/4" THCS LL	11185 MF 100/4" PIR LL
Ø120	11124 MF 120/5"	11128 MF 120/5" T	11132 MF 120/5" LL	11136 MF 120/5" T LL	11149 MF 120/5" THCS LL	11186 MF 120/5" PIR LL
Ø150	11125 MF 150/6"	11129 MF 150/6" T	11133 MF 150/6" LL	11137 MF 150/6" T LL	11176 MF 150/6" THCS LL	11187 MF 150/6" PIR LL

TECHNICAL DATA

MODELS	V~50HZ	W max	A max	RPM max	MAX ARIFLOW		MAX PRESSURE		Lp dB(A) 3m max	MAX °C	KG
					m³/h	l/s	mmH ₂ O	Pa			
MF 90/3.5"	220-240	14	0.08	2500	65	18	2.5	25	28.8	50	0.50
MF 100/4"	220-240	15	0.09	2400	85	24	3	29	31.0	50	0.51
MF 120/5"	220-240	20	0.12	2150	175	49	5	49	34.4	50	0.61
MF 150/6"	220-240	28	0.15	2100	335	93	6	59	40.1	50	0.97

PUNTO FILO RANGE | TECHNICAL DATA FOR REGULATION N° 1254/2014/UE

	UNIT OF MEASURE	MF 90/3.5"	MF 100/4"	MF 120/5"	MF 150/6"
		Supplier's name or trade mark	-	Vortice	Vortice
Specific Energy Consumption class SEC in average climate zone	-	NA*	NA*	NA*	NA*
Specific Energy Consumption class SEC average		-2.5	-5.4	-8.8	-9.9
Specific Energy Consumption class SEC cold	kWh/m ² year	-15.9	-18.7	-22.1	-23.2
Specific Energy Consumption class SEC warm		5.1	2.3	1.1	-2.2
Declared typology	-	RVU-U*	RVU-U*	RVU-U*	RVU-U*
Type of drive	-	NA	NA	NA	NA
Type of heat recovery system HRS	-	none	none	none	none
Thermal efficiency of heat recovery at reference air flow	%	NA	NA	NA	NA
Maximum flow rate	m³/h	55	78	173	332
Electric power input of the fan drive, including any motor control equipment, at maximum flow rate	W	12.9	14.1	21.4	26.7
Sound power level LWA	LWA [DB(A)]	49	52	60	61
Reference flow rate	m³/s	0.0107	0.0152	0.0336	0.0646
Reference pressure difference	Pa	19	17	24	32
SPI	W/(m³/h)	0.33247	0.24908	0.15111	0.11833
Control factor CTRL	-	1	1	1	1
Control typology	-	manual	manual	manual	manual
Maximum internal leakage rates	%	NA	NA	NA	NA
Maximum external leakage rates	%	NA	NA	NA	NA
Mixing rate	-	NA	NA	NA	NA
Position and description of visual filter warning	-	NA	NA	NA	NA
Airflow sensitivity to pressure variations at + 20 Pa and - 20 Pa	-	NA	NA	NA	NA
Indoor/outdoor air tightness	m³/h	NA	NA	NA	NA
Annual electricity consumption (AEC)	kWh electricity/year	458	343	208	163
AHS average Annual heating saved		1397	1397	1397	1397
AHS cold Annual heating saved	kWh primary energy/year	2732	2732	2732	2732
AHS warm Annual heating saved		632	632	632	632

* RVU-U: Unit Ventilation Residential - Unidirectional - **NRVU-U: Unit Ventilation Non Residential - Unidirectional - ***MSD: Multi-Speed Drive - NA: Not applicable



RESIDENTIAL VENTILATION

PUNTO FILO RANGE

DIMENSIONS

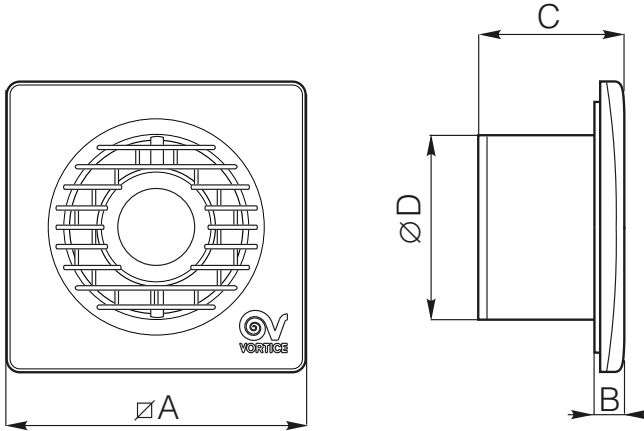

MODELS	Ø A	B	C	Ø D
MF 90/3.5"	159	17	77	92.5
MF 100/4"	159	17	77	98
MF 120/5"	179	17	89	119
MF 150/6"	214	17	96	156

Dimensions (mm)

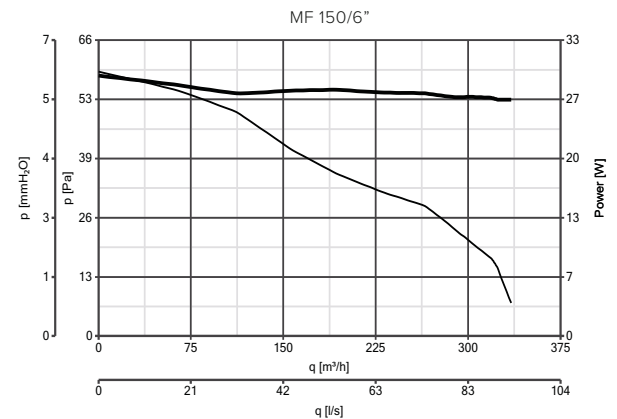
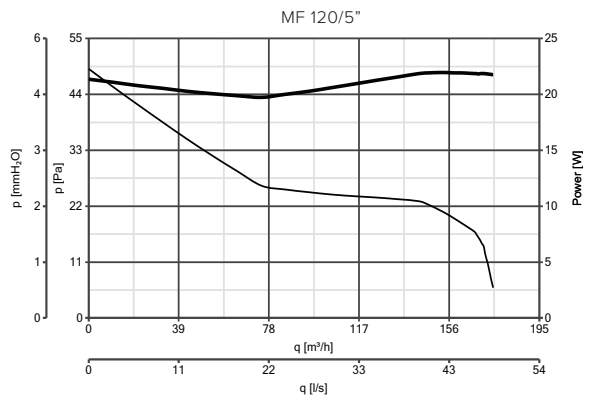
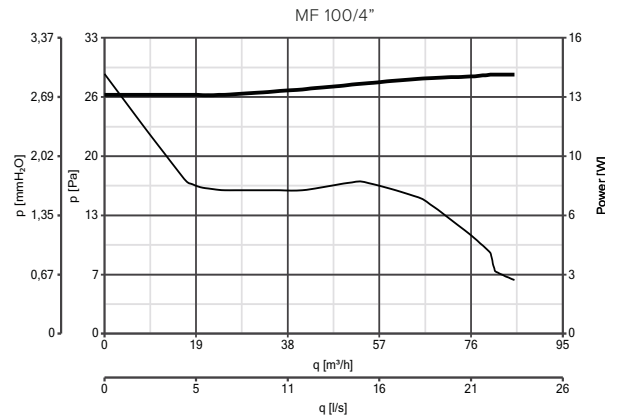
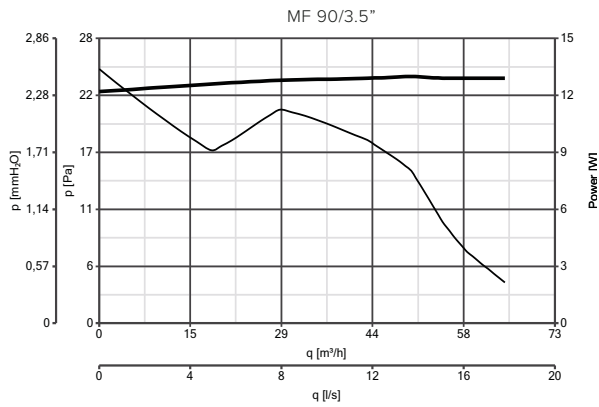

PERFORMANCE CURVES



— Power consumption — Delivery



CONTROLLER

MODELS	DESCRIPTION	CODE	PRODUCT
	C 1.5 - Electronic speed controller 1.5 A	12966	11122 - 11123 - 11131 - 11124 - 11132 11125 - 11133
	SCB KIT - Built-in controller adaptor for C 1.5	22481	12966

ACCESSORIES ON REQUEST

MODELS	DESCRIPTION	CODE	PRODUCT	
	SF KIT - Ceiling kit	90 - 100	22162	11122 - 11126 - 11138 - 11123 - 11131 - 11127 - 11135 - 11185 - 11139
		120	22163	11124 - 11132 - 11128 - 11136 - 11186 - 11149
		150	22164	11125 - 11133 - 11129 - 11137 - 11187 - 11176

APPLICATIONS





Design: F. Trabucco & Associates



PUNTO FOUR RANGE

Wall axial fans

Wall, ceiling and false-ceiling axial fans, ideal for ventilation in small and medium-size residential and commercial premises whose layout allows for direct exhaust or exhaust in short length pipes. The elegant front panel which hides the hole behind it reduces the aesthetic impact of the installed product.

Key features

- Modern design, in line with the latest trends, which combines aesthetic elegance with easy product cleaning and maintenance.
- Reduced exhaust sleeve depth, compatible with installation immediately upstream of a 90° bend.
- High protection from water, suitable for use in Zone 1 bathroom installations and in the presence of high relative humidity.

Version

6 models, with nominal diameter between 90 and 120 mm, also in the versions with timer.

Technical features

- White, shock-proof, plastic resin (ABS) panels, prevents ageing caused by exposure to sunlight ("UV resistant").
- Shaded pole motors, heat protected, with shafts mounted on bushings with self-centring and self-lubricating neck to guarantee silent, reliable operation for a duration consistent with the destination of use of the products. Speed adjustment using Vortice accessory devices.
- Axial impellers with airfoil shaped blades to combine high performance with low noise emissions.
- Non-return valves on the delivery spigots to prevent unwanted inflows of air and bad odours when the device is switched off.
- T models equipped with electronic timer for automatic product switch-off after a pre-fixed period of time, which can be set in the installation phase, from 3'-20' (default setting 3').
- Performance and safety certified by third party body (IMQ)
- Protection rating from dust and water: IPX4.
- Class of electric isolation: II \square (earthing not required).

TECHNICAL DATA

MODELS	CODE		V~50HZ	W max	A max	RPM max	MAX AIRFLOW		MAX PRESSURE		Lp dB(A) 3m max	MAX °C	KG
	BASIC	TIMER					m ³ /h	l/s	mmH ₂ O	Pa			
MFO 90/3.5"	11143	11144	220-240	14	0.08	2540	65	18	2.5	25	29.6	50	0.55
MFO 100/4"	11145	11146	220-240	15	0.09	2400	85	24	3.0	29	33.1	50	0.55
MFO 120/5"	11147	11148	220-240	20	0.12	2240	175	49	5.0	49	39.1	50	0.78



PUNTO FOUR RANGE | TECHNICAL DATA FOR REGULATION N° 1254/2014/UE

	UNIT OF MEASURE	MFO 90/3.5"	MFO 100/4"	MFO 120/5"
Supplier's name or trade mark	-	Vortice	Vortice	Vortice
Specific Energy Consumption class SEC in average climate zone	-	NA*	NA*	NA*
Specific Energy Consumption class SEC average	-	-2.1	-4.1	-8.9
Specific Energy Consumption class SEC cold	kWh/m ² year	-15.5	-17.5	-22.3
Specific Energy Consumption class SEC warm	-	5.6	3.5	1.3
Declared typology	-	RVU-U*	RVU-U*	RVU-U*
Type of drive	-	NA	NA	NA
Type of heat recovery system HRS	-	none	none	none
Thermal efficiency of heat recovery at reference air flow	%	NA	NA	NA
Maximum flow rate	m ³ /h	54	68	171
Electric power input of the fan drive, including any motor control equipment, at maximum flow rate	W	12.9	14.0	18.5
Sound power level LWA	LWA [DB(A)]	50	54	60
Reference flow rate	m ³ /s	0.0104	0.0132	0.0333
Reference pressure difference	Pa	19	14	19
SPI	W/(m ³ /h)	0.34446	0.28571	0.14620
Control factor CTRL	-	1	1	1
Control typology	-	manual	manual	manual
Maximum internal leakage rates	%	NA	NA	NA
Maximum external leakage rates	%	NA	NA	NA
Mixing rate	-	NA	NA	NA
Position and description of visual filter warning	-	NA	NA	NA
Airflow sensitivity to pressure variations at + 20 Pa and - 20 Pa	-	NA	NA	NA
Indoor/outdoor air tightness	m ³ /h	NA	NA	NA
Annual electricity consumption (AEC)	kWh electricity/year	475	394	201
AHS average Annual heating saved	-	1397	1397	1397
AHS cold Annual heating saved	kWh primary energy/year	2732	2732	2732
AHS warm Annual heating saved	-	632	632	632

* RVU-U: Unit Ventilation Residential - Unidirectional

** NRUVU-U: Unit Ventilation Non Residential - Unidirectional

*** MSD: Multi-Speed Drive

NA: Not applicable

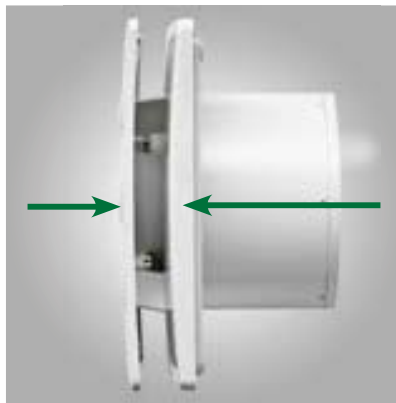
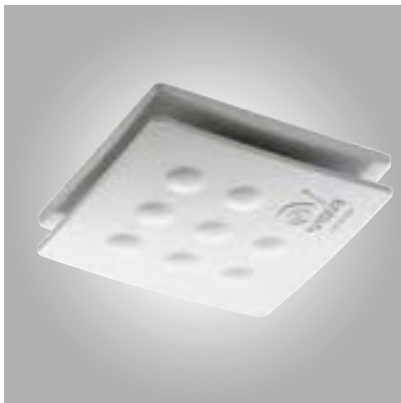



RESIDENTIAL VENTILATION

PUNTO FOUR RANGE

DIMENSIONS

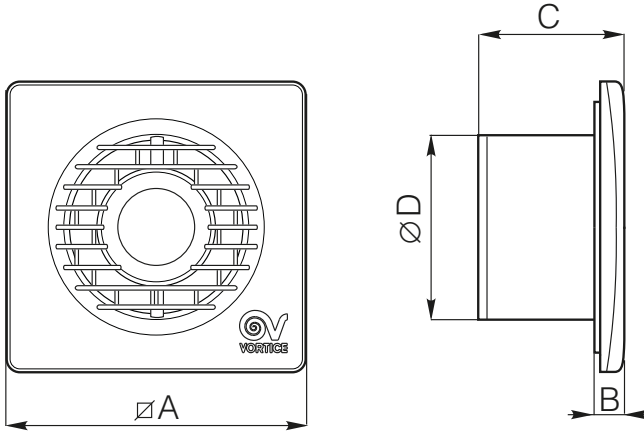

MODELS	Ø A	B	C	Ø D
MFO 90/3.5"	158	37	97	92.4
MFO 100/4"	158	37	97	98.4
MFO 120/5"	178	42,3	114	118.9

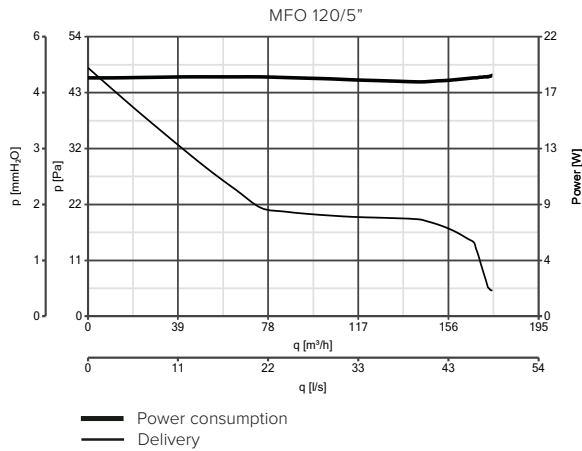
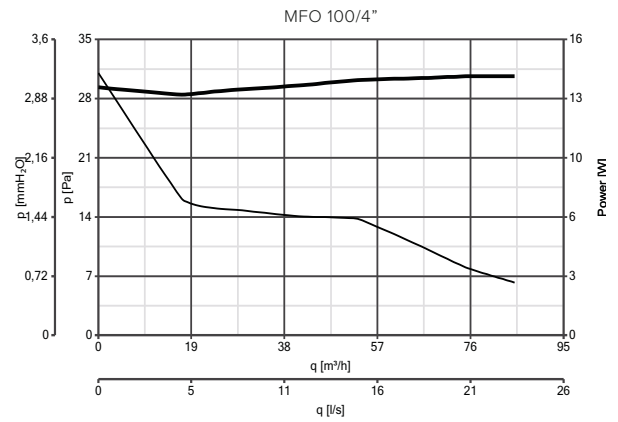
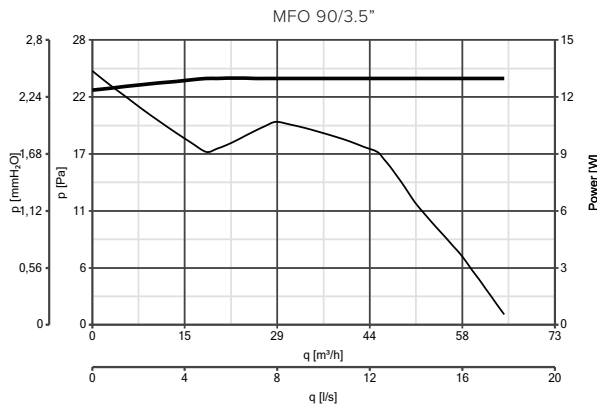

Dimensions (mm)

PERFORMANCE CURVES





CONTROLLER

MODELS	DESCRIPTION	CODE	PRODUCT
	C 1.5 - Electronic speed controller 1.5 A	12966	11143 - 11145 - 11147
	SCB KIT - Built-in controller adaptor for C 1.5	22481	12966

ACCESSORIES ON REQUEST

MODELS	DESCRIPTION	CODE	PRODUCT	
	SF KIT - Ceiling kit	90 - 100	22162	11143 - 11144 - 11145 - 11146
		120	22163	11147 - 11148

APPLICATIONS





PUNTO GHOST RANGE

Axial duct fans

LONG LIFE 80.000 h

ideal for ventilation in small and medium-size residential and commercial premises whose layout allows for direct exhaust or exhaust in short length pipes. Also suitable for distributing heat between adjacent rooms.

Key features

- Small axial dimensions, compatible with insertion inside dividing walls set between adjacent rooms.
- High protection from water, suitable for use in Zone 1 bathroom installations and in the presence of high relative humidity.
- Highly flexible horizontal and vertical installation inside walls and ceilings

Design: F. Trabucco & Associates



Version

- 4 models, also in timer version, with nominal diameter between 90 and 150 mm.

Technical features

- White, shock-proof, plastic resin (ABS) panels, prevents ageing caused by exposure to sunlight ("UV resistant").
- Shaded pole motors, heat protected, with shafts mounted on bushings with self centring and self-lubricating neck to guarantee silent, reliable operation for a duration consistent with the destination of use of the products. Speed adjustment using Vortice accessory devices.
- Axial impellers with airfoil shaped blades to combine high performance with low noise emissions.
- MG 90/3.5" T models equipped with electronic timer for automatic product switch over after a pre-fixed period of time, which can be set in the installation phase, from 3'-20' (default setting 3').
- Performance and safety certified by third party body (IMQ)
- Protection rating from dust and water: IPX4.
- Class of electric isolation: II \square (earthing not required).

TECHNICAL DATA

MODELS	CODE		V~50HZ	W max	A max	RPM max	MAX AIRFLOW		MAX PRESSURE		Lp dB(A) 3m max	MAX °C	KG
	BASIC	TIMER					m ³ /h	l/s	mmH ₂ O	Pa			
MG 90/3.5"	11110	11111	220-240	18	0,10	2450	65	18	2,1	21	38	40	0,40
MG 100/4" LL	11100	11101	220-240	18	0,10	2415	80	22,2	2,6	25	39	40	0,43
MGK 100/4" LL	11106	-	220-240	18	0,10	2415	80	22,2	2,6	25	39	40	0,90
MG 120/5"	11116	-	220-240	20	0,12	2250	160	44	4,5	44	43	50	0,56
MG 120/5" LL	11102	11103	220-240	20	0,12	2250	160	44,4	4,5	44	43	50	0,56
MG 150/6"	11117	-	220-240	30	0,18	2200	89	89	7,0	69	48	50	0,80
MG 150/6" LL	11104	11105	220-240	30	0,18	2200	88,9	88,9	7,0	69	48	50	0,80



PUNTO GHOST RANGE | TECHNICAL DATA FOR REGULATION N° 1254/2014/UE

	UNIT OF MEASURE	MG 90/3.5" MG 100/4"	MG 120/5"	MFO 150/6"
Supplier's name or trade mark	-	Vortice	Vortice	Vortice
Specific Energy Consumption class SEC in average climate zone	-	NA*	NA*	NA*
Specific Energy Consumption class SEC average	-	-5,4	-7,6	-10,0
Specific Energy Consumption class SEC cold	kWh/m ² year	-18,8	-21,0	-23,4
Specific Energy Consumption class SEC warm	-	2,2	0,0	-2,4
Declared typology	-	RVU-U*	RVU-U*	RVU-U*
Type of drive	-	NA	NA	NA
Type of heat recovery system HRS	-	none	none	none
Thermal efficiency of heat recovery at reference air flow	%	NA*	NA*	NA*
Maximum flow rate	m ³ /h	77	157	311
Electric power input of the fan drive, including any motor control equipment, at maximum flow rate	W	13,7	20,5	25,0
Sound power level LWA	LWA [DB(A)]	60	64	69
Reference flow rate	m ³ /s	0,0150	0,0305	0,0605
Reference pressure difference	Pa	14	18	30
SPI	W/(m ³ /h)	0,24861	0,18471	0,11484
Control factor CTRL	-	1	1	1
Control typology	-	manual	manual	manual
Maximum internal leakage rates	%	NA	NA	NA
Maximum external leakage rates	%	NA	NA	NA
Mixing rate	-	NA	NA	NA
Position and description of visual filter warning	-	NA	NA	NA
Airflow sensitivity to pressure variations at + 20 Pa and – 20 Pa	-	NA	NA	NA
Indoor/outdoor air tightness	m ³ /h	NA	NA	NA
Annual electricity consumption (AEC)	kWh electricity/year	343	255	158
AHS average Annual heating saved	-	1397	1397	1397
AHS cold Annual heating saved	kWh primary energy/year	2732	2732	2732
AHS warm Annual heating saved	-	632	632	632

* RVU-U: Unit Ventilation Residential - Unidirectional

** NRVU-U: Unit Ventilation Non Residential - Unidirectional

*** MSD: Multi-Speed Drive

NA: Not applicable



DIMENSIONS

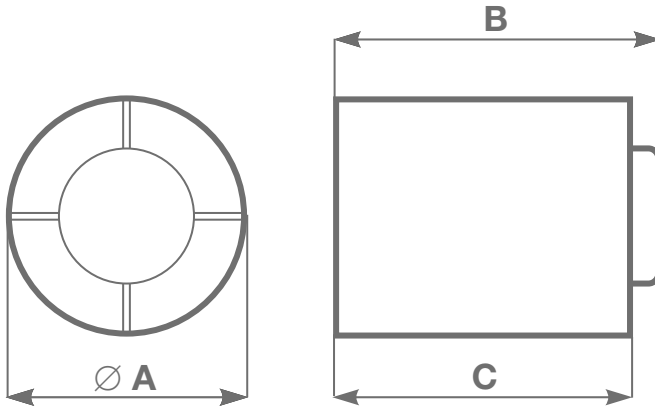

MODELS	Ø A	B	C
MG 90/3.5"	92.5	92	89
MG 90/3.5" T	92.5	96.5	89
MG 120/5"	119	103	100
MG 150/6"	155	110	107

Dimensions (mm)

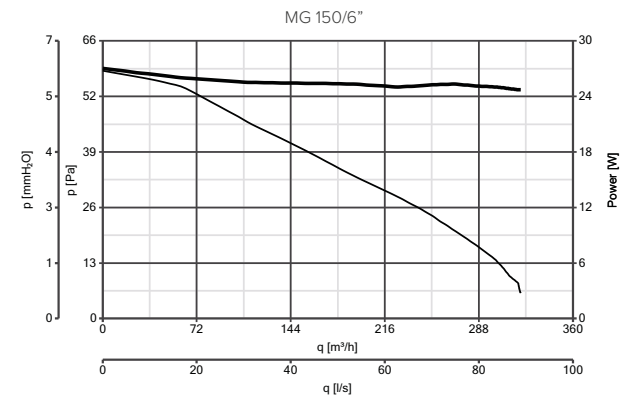
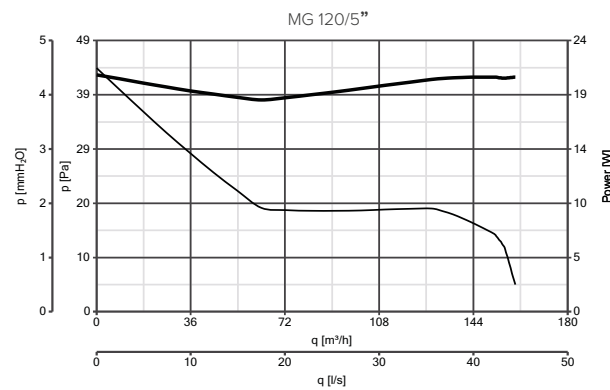
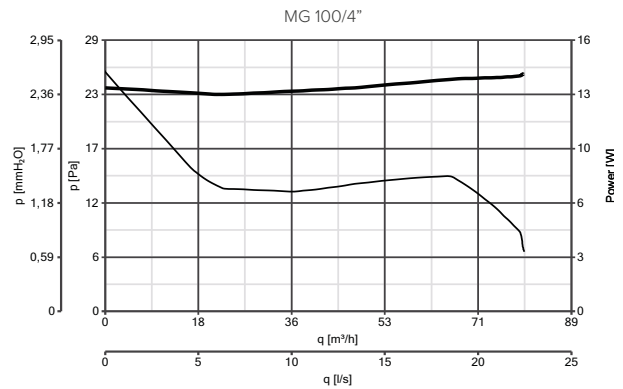
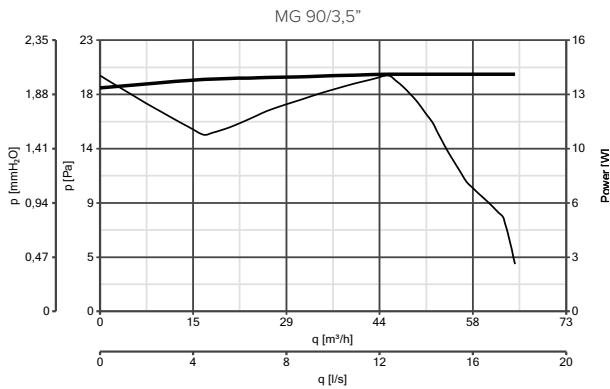

PERFORMANCE CURVES







— Power consumption — Delivery



CONTROLLER

MODELS	DESCRIPTION	CODE	PRODUCT
	C 1.5 - Electronic speed controller 1.5 A	12966	11110 - 11100 - 11116 - 11102 - 11117 - 11104
	SCNRB - Electronic speed controller built-in	12971	11110 - 11116 - 11117
	SCB KIT - Built-in controller adaptor for C 1.5	22481	12966

ACCESSORIES ON REQUEST

MODELS	DESCRIPTION	CODE	PRODUCTS	
	LOFT MOUNTING BRACKETS	Ø 90/100	22259	11110 - 11111 - 11100 - 11101
		Ø 120/5	22260	11116 - 11102 - 11103
		Ø 150/6	22261	11117 - 11104 - 11105
	INSTALLATION KIT COMP.	Ø 90/3	22265	11110 - 11111
		Ø 100/4	22140	11100 - 11101
		Ø 120/5	22263	11116
		Ø 150/6	22264	11117
	FLEXIBLE DUCT	Ø 90/100	22250	11110 - 11111
		Ø 120/5	22251	11116 - 11102 - 11103
		Ø 150/6	22252	11117 - 11104 - 11105
	TELESCOPIC WALL LINER	Ø 100/4	22256	11110 - 11111
		Ø 120/5	22257	11116 - 11102 - 11103
		Ø 150/6	22258	11117 - 11104 - 11105

APPLICATIONS





PUNTO EVO FLEXP RANGE

Wall axial fans **LONG LIFE 30.000 h**

Wall, ceiling and false-ceiling axial fans, ideal for ventilation in small and medium-size residential and commercial premises, also in the presence of medium length exhaust ducts.

Key features

- Very low noise emissions for high comfort of use.
- Very high (IP45) protection rating from dust and water jets, exceeding the requirements of use in Zone 1 bathroom installations.
- Modern design, in line with the latest trends, which combines aesthetic elegance with easy product cleaning and maintenance.
- Sealed non-return valves to prevent unwanted inflows of air and bad odours when the device is switched off.
- Reduced exhaust sleeve depth, compatible with installation immediately upstream of a 90° bend.
- Low consumption

Version

- 4 models, with nominal diameter 100 and 120 mm, also in the versions with timer.

Technical features

- White, shock-proof, plastic resin (ABS) panels, prevents ageing caused by exposure to sunlight ("UV resistant").
- Shaded pole motors, heat protected, with shafts mounted on ball bearings to guarantee long lasting (at least 30,000 h) continuous service at the maximum plate temperature. Speed adjustment using Vortice accessory devices.
- Helico-centrifugal impellers optimised to ensure high performance, low consumption and low noise emissions, when coupled with underlying flow conditioners.
- Air-tight butterfly valve on the delivery spigots, to prevent unwanted inflows of air and bad odours when the device is switched off.
- T models equipped with electronic timer for automatic product switch-off after a pre-fixed period of time, which can be set in the installation phase, from 3'-20' (default setting 3').
- Performance and safety certified by third party body (IMQ)
- Protection rating from dust and water: IP45.
- Class of electric isolation: II □ (earthing not required).



TECHNICAL DATA

MODELS	CODE		V~50HZ	W max	A max	RPM max	MAX AIRFLOW		MAX PRESSURE		Lp dB(A) 3m max	MAX °C	KG
	BASIC	TIMER					m³/h	l/s	mmH ₂ O	Pa			
MEX 100/4" LL 1S	11313	11314	230	9	0.052	2175	90	25	4	39.23	26.9	50	0.60
MEX 120/5" LL 1S	11333	11334	230	13	0.095	2075	175	48.6	5	49.04	32.3	50	0.77



PUNTO EVO FLEXP RANGE | TECHNICAL DATA FOR REGULATION N° 1254/2014/UE

	UNIT OF MEASURE	MF 90/3.5"	MF 150/6"
Supplier's name or trade mark	-	Vortice	Vortice
Specific Energy Consumption class SEC in average climate zone	-	NA*	NA*
Specific Energy Consumption class SEC average	-	-9,9	-10,0
Specific Energy Consumption class SEC cold	kWh/m ² year	-23,2	-23,4
Specific Energy Consumption class SEC warm	-	-2,2	-2,4
Declared typology	-	RVU-U*	RVU-U*
Type of drive	-	NA	NA
Type of heat recovery system HRS	-	none	none
Thermal efficiency of heat recovery at reference air flow	%	NA*	NA*
Maximum flow rate	m ³ /h	87	168
Electric power input of the fan drive, including any motor control equipment, at maximum flow rate	W	8,0	14,1
Sound power level LWA	LWA [DB(A)]	47	53
Reference flow rate	m ³ /s	0,0169	0,0327
Reference pressure difference	Pa	21	19
SPI	W/(m ³ /h)	0,11823	0,11480
Control factor CTRL	-	1	1
Control typology	-	manual	manual
Maximum internal leakage rates	%	NA	NA
Maximum external leakage rates	%	NA	NA
Mixing rate	-	NA	NA
Position and description of visual filter warning	-	NA	NA
Airflow sensitivity to pressure variations at + 20 Pa and - 20 Pa	-	NA	NA
Indoor/outdoor air tightness	m ³ /h	NA	NA
Annual electricity consumption (AEC)	kWh electricity/year	163	158
AHS average Annual heating saved	-	1397	1397
AHS cold Annual heating saved	kWh primary energy/year	2732	2732
AHS warm Annual heating saved	-	632	632

* RVU-U: Unit Ventilation Residential - Unidirectional - **NRVU-U: Unit Ventilation Non Residential - Unidirectional - ***MSD: Multi-Speed Drive - NA: Not applicable





RESIDENTIAL VENTILATION

PUNTO EVO FLEXO RANGE

DIMENSIONS

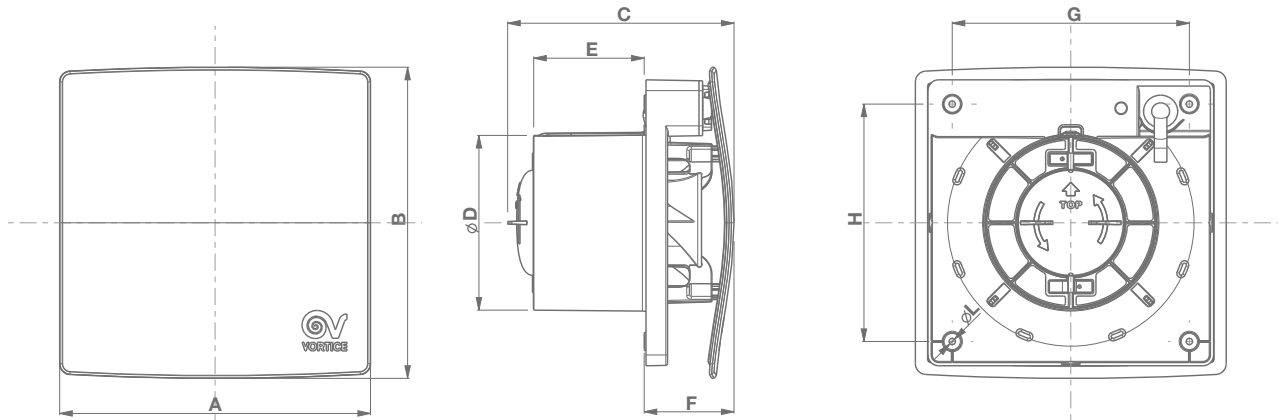

MODELS	A	B	C	D	E	F	G	H	Ø L
MEX 100/4" LL 1S	173	173	126	98	61.5	50	132	132	3.5
MEX 100/4" LL 1S T	173	173	126	98	61.5	50	132	132	3.5
MEX 120/5" LL 1S	193	193	138	119	71	53	152	152	3.5
MEX 120/5" LL 1S T	193	193	138	119	71	53	152	152	3.5

Dimensions (mm)

PERFORMANCE CURVES

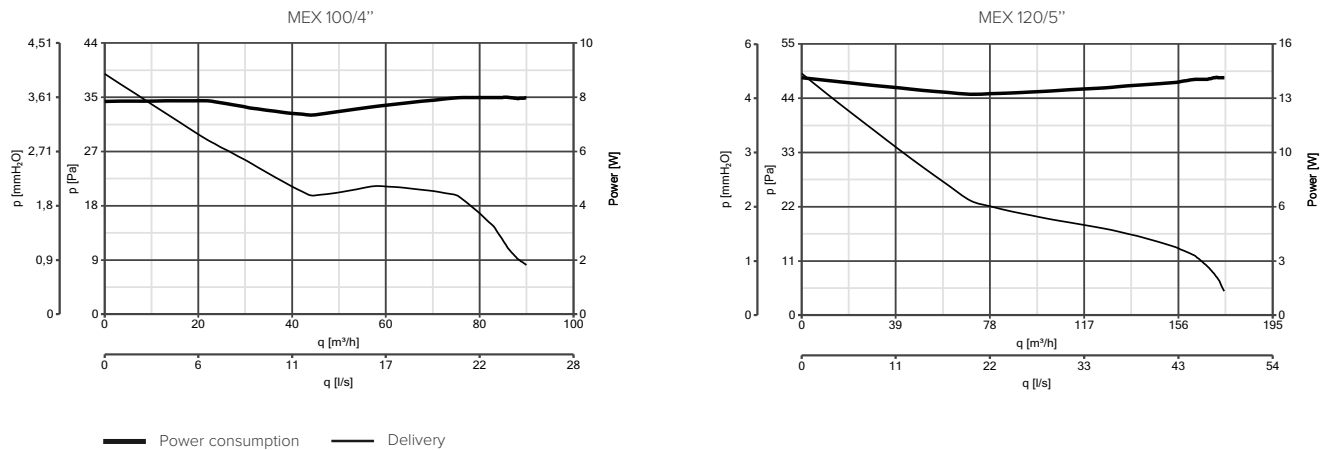



EXPLODED VIEW



APPLICATIONS





PUNTO EVO RANGE

Wall axial fans **LONG LIFE 30.000 h**

Wall, ceiling and false-ceiling axial fans, ideal for ventilation in small and medium-size residential and commercial premises, also in the presence of medium length exhaust ducts.

Key features

- Very low noise emissions for high comfort of use.
- Very high (IP45) protection rating from dust and water jets, exceeding the requirements of use in Zone 1 bathroom installations.
- 2-speed motors designed to ensure low consumption.
- Sealed non-return valves to prevent unwanted inflows of air and bad odours when the device is switched off.
- Reduced exhaust sleeve depth, compatible with installation immediately upstream of a 90° bend.
- Sophisticated electronic equipment that meets a particularly wide range of needs.



IPX5





Version

- 10 models, with nominal diameter 100 and 120 mm, available in versions with a timer, with an advanced timer, with humidity sensor and presence sensor.

Technical features

- White, shock-proof, plastic resin (ABS) panels, prevents ageing caused by exposure to sunlight ("UV resistant").
- Shaded pole motors, heat protected, 2-speed with shafts mounted on ball bearings to guarantee long lasting (at least 30,000 h) continuous service at the maximum plate temperature. Speed adjustment using Vortice accessory devices.
- Helico-centrifugal impellers optimised to ensure high performance, low consumption and low noise emissions, when coupled with underlying flow conditioners.
- Air-tight butterfly valve on the delivery spigots, to prevent unwanted inflows of air and bad odours when the device is switched off.
- Performance and safety certified by third party body (IMQ)
- Protection rating from dust and water: IP45.
- Class of electric isolation: II □ (earthing not required).

RANGE

Diam.	 BASIC LONG LIFE	 TIMER LONG LIFE	 TIMER EVOLUTO LONG LIFE	 TP HCS LONG LIFE	 PIR LONG LIFE
Ø100	11260 ME 100/4" LL	11264 ME 100/4" LL T	11261 ME 100/4" LL TP	11262 ME 100/4" LL TP HCS	11263 ME 100/4" LL PIR
Ø120	11270 ME 120/5" LL	11274 ME 120/5" LL T	11271 ME 120/5" LL TP	11272 ME 120/5" LL TP HCS	11273 ME 120/5" LL PIR



The **Basic models** is equipped with a 2-speed PCB.



T models equipped with electronic timer for automatic product switch-over from maximum to minimum speed after a pre-fixed period of time after your switch the light off. The delay can be set in the installation phase from 3'-20' (default setting 3'). Alternatively, if the device has been wired to operate at a single speed, the timer determines its delayed stop.



TP models equipped with electronic timer for delayed product switch-over to maximum and to minimum speed: the product running at minimum speed goes to maximum speed after a pre-set time (from 0" to 120", default 45"), after the light is switched on, and goes back to minimum speed after a pre-set amount of time (from 6' to 21', default 6'), from when you switch the light off. The advanced electronics of the TP models also permits (HOLIDAY function) for correct ventilation of the room even in the event of prolonged periods of non-use. It is in fact possible to program periodic (every 8, 12 or 24 h) operating cycles at maximum speed at durations that can be set at 6', 15', 18' or 21'. Alternatively, if the device has been wired to operate at a single speed, the timer commands its start and stop.



PIR models equipped with an IR presence sensor for automatic product switch-over from minimum to maximum speed in the presence of occupants in the serviced room. The board integrates an electronic timer for automatic return to minimum speed after the occupants have left the premises. The duration of the timer can be set at installation within the interval 3'-20' (default setting 3'). Alternatively, if the device has been wired to operate at a single speed, the presence sensor commands automatic start-up.



TP-HCS models equipped with a circuit board integrating the advanced timer of TP models combined with a relative humidity sensor (RH) that can be adjusted on 4 pre-set threshold levels (60%, 70%, 80%, 90 %, default 70%). In addition to the operating modes described with reference to the TP models, the TP-HCS versions allow for automatic product switch-over from minimum to maximum speed when the RH limit value has been exceeded. The device returns to operation at the minimum speed when the RH drops 15% below the threshold level. The advanced electronics of TP-HCS models also allows for automatic switch-over to maximum speed in the presence of sudden increases in the RH level (+ 20% in a time of no less than 10'). Alternatively, if the device has been wired to operate at a single speed, the RH sensor commands its start and stop.

TECHNICAL DATA

MODELS	V~50HZ	W min/max	A min/max	RPM min/max	MAX AIRFLOW		MAX PRESSURE		Lp dB(A)* 3m min/max	MAX °C	KG
					m³/h min/max	l/s min/max	mmH₂O min/max	Pa min/max			
ME 100/4" LL	220-240	5 9	0.039 0.052	1700 2240	65 95	18.1 26.4	2.5 4.7	22.52 46.09	20.8 26.9	50	0.60
ME 120/5" LL	220-240	10 13	0.060 0.080	1490 2070	120 175	33.3 48.6	2.3 5.0	22.56 49.04	24.0 32.3	50	0.77



RESIDENTIAL VENTILATION

PUNTO EVO RANGE

PUNTO EVO RANGE | TECHNICAL DATA FOR REGULATION N° 1254/2014/UE

	UNIT OF MEASURE	ME 100/4" LL	MF 150/6"
Supplier's name or trade mark	-	Vortice	Vortice
Specific Energy Consumption class SEC in average climate zone	-	NA*	NA*
Specific Energy Consumption class SEC average	-	-9.9	-9.9
Specific Energy Consumption class SEC cold	kWh/m ² year	-23.2	-23.3
Specific Energy Consumption class SEC warm	-	-2.2	-2.3
Declared typology	-	RVU-U*	RVU-U*
Type of drive	-	NA	NA
Type of heat recovery system HRS	-	none	none
Thermal efficiency of heat recovery at reference air flow	%	NA	NA
Maximum flow rate	m ³ /h	93	168
Electric power input of the fan drive, including any motor control equipment, at maximum flow rate	W	8.1	14.5
Sound power level LWA	LWA [DB(A)]	68	53
Reference flow rate	m ³ /s	0.0181	0.0327
Reference pressure difference	Pa	22	18
SPI	W/(m ³ /h)	0.11828	0.11735
Control factor CTRL	-	1	1
Control typology	-	manual	manuale
Maximum internal leakage rates	%	NA	NA
Maximum external leakage rates	%	NA	NA
Mixing rate	-	NA	NA
Position and description of visual filter warning	-	NA	NA
Airflow sensitivity to pressure variations at + 20 Pa and – 20 Pa	-	NA	NA
Indoor/outdoor air tightness	m ³ /h	NA	NA
Annual electricity consumption (AEC)	kWh electricity/year	163	162
AHS average Annual heating saved	-	1397	1397
AHS cold Annual heating saved	kWh primary energy/year	2732	2732
AHS warm Annual heating saved	-	632	632

* RVU-U: Unit Ventilation Residential - Unidirectional

** NRVU-U: Unit Ventilation Non Residential - Unidirectional

*** MSD: Multi-Speed Drive

NA: Not applicable



DIMENSIONS

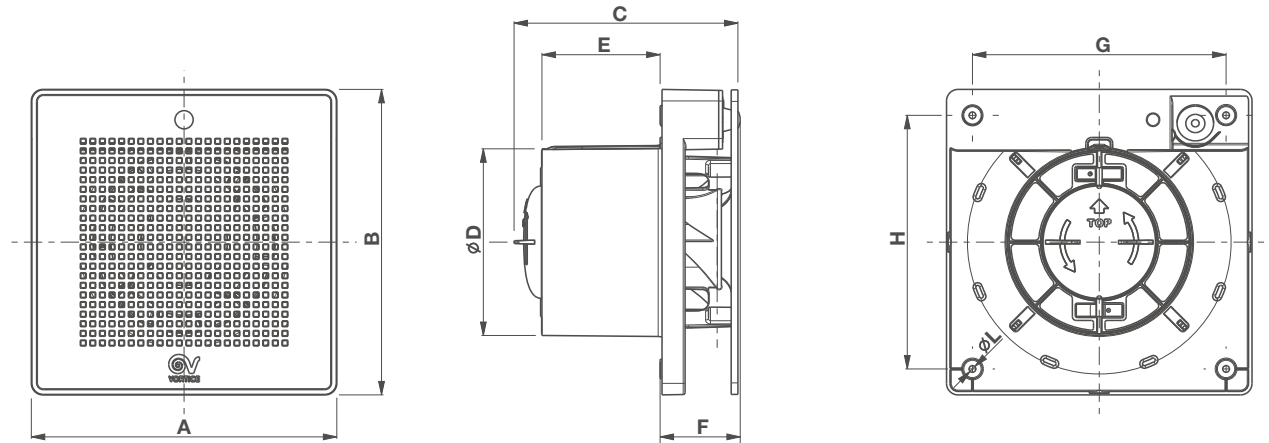

MODELS	A	B	C	D	E	F	G	H	ØL
ME 100/4" LL	159	159	116.5	98	61.5	40.5	132	132	3.5
ME 100/4" LL PIR	159	159	118	98	61.5	42	132	132	3.5
ME 120/5" LL	179	179	127	118	71	42.5	152	152	3.5
ME 120/5" LL PIR	179	179	128.5	118	71	44	152	152	3.5

Dimensions (mm)

EXPLODED VIEW

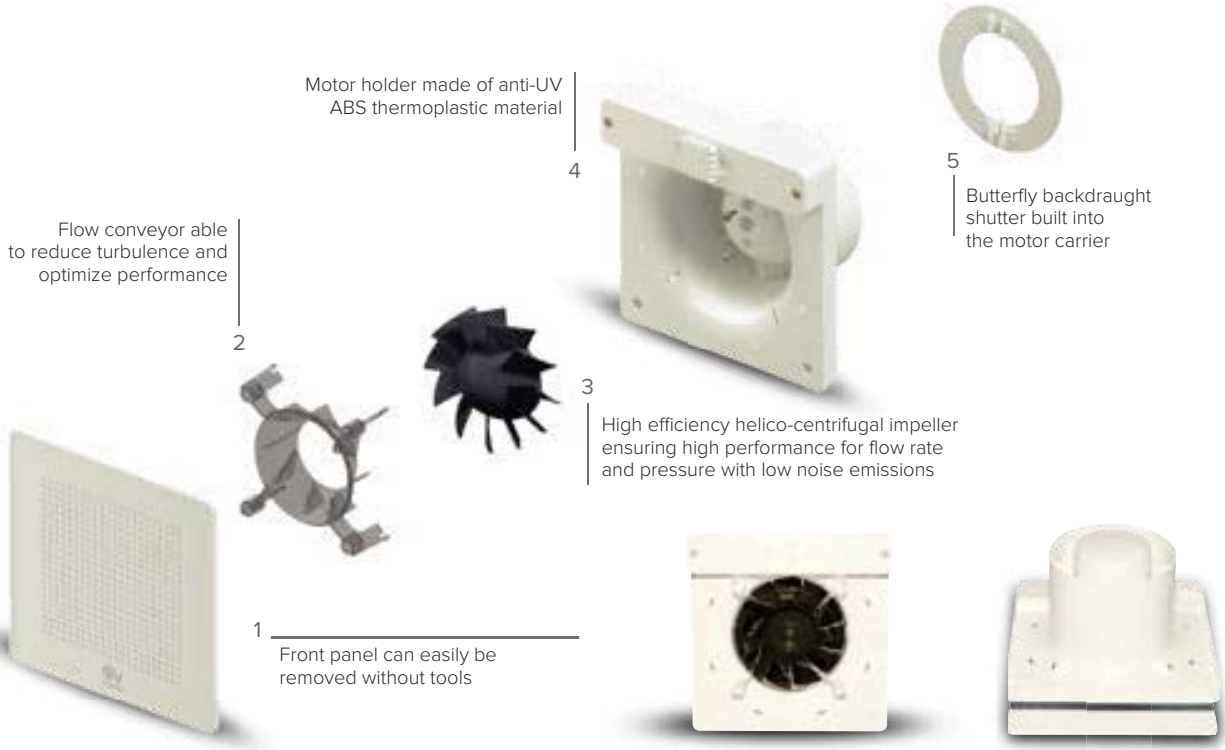



PERFORMANCE CURVES

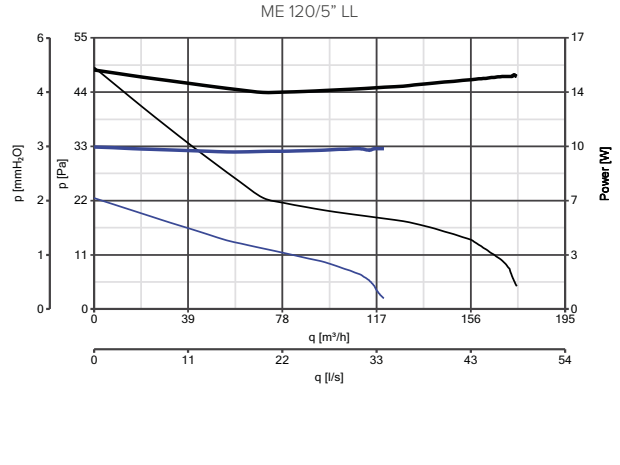
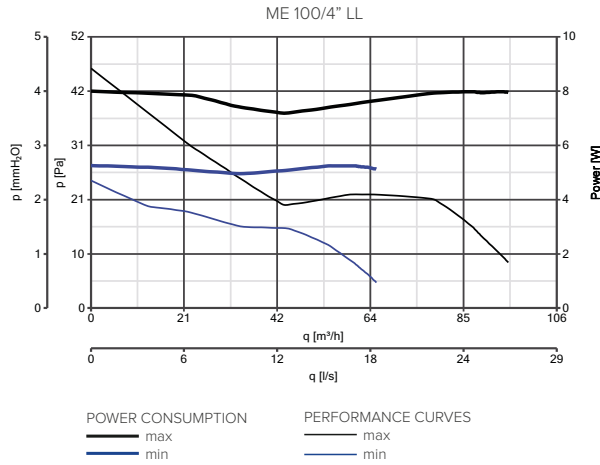

APPLICATIONS





APPLICATIONS

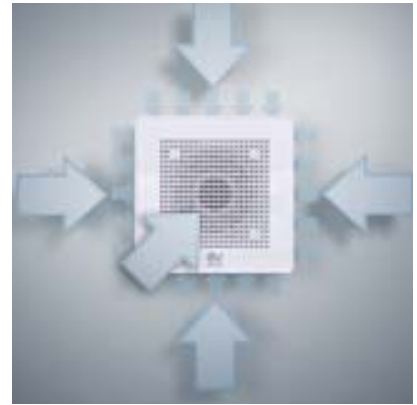



PUNTO EVO ES RANGE

Wall axial fans energy savings **LONG LIFE 30.000 h**

Wall, ceiling and false-ceiling axial fans, ideal for continuous ventilation (thanks to very low consumption of the electronic switch-over - EC brushless motors - used) in small and medium-size residential and commercial premises, also in the presence of medium length exhaust ducts.

Key features

- 2 speed EC motors with particularly low consumption
- Very low noise emissions for high comfort of use.
- Very high (IP45) protection rating from dust and water jets, exceeding the requirements of use in Zone 1 bathroom installations.
- Sealed non-return valves to prevent unwanted inflows of air and bad odours when the device is switched off.
- Reduced exhaust sleeve depth, compatible with installation immediately upstream of a 90° bend.



IPX5

Version

- 2 models, with nominal diameter 100 and 120 mm.

Technical features

- White, shock-proof, plastic resin (ABS) panels, prevents ageing caused by exposure to sunlight ("UV resistant").
- 2 speed, EC motors (brushless), heat protected and characterised by very low consumption, with shafts mounted on ball bearings to guarantee long lasting (at least 40,000 h) continuous service at the maximum plate temperature.
- Helico-centrifugal impellers optimised to ensure high performance, low consumption and low noise emissions, when coupled with underlying flow conditioners.
- Air-tight butterfly valve on the delivery spigots, to prevent unwanted inflows of air and bad odours when the device is switched off.
- Safety certified by third party body (IMQ)
- Protection rating from dust and water: IP45.
- Class of electric isolation: II □ (earthing not required).

TECHNICAL DATA

MODELS	CODE	V~50HZ	W min/max	A min/max	RPM min/max	MAX AIRFLOW		MAX PRESSURE		Lp dB(A)* 3m min/max	Lw dB(A) 3m min/max	MAX °C**	KG
						m ³ /h min/max	l/s min/max	mmH ₂ O min/max	Pa min/max				
ME 100/4" ES	11268	230	2.1 3.6	0.030 0.041	1680 2280	65 95	18.1 26.4	2.7 5.1	26.5 50.0	21.0 27.8	41.5 48.3	50	0.64
ME 120/5" ES	11269	230	3.3 7.0	0.040 0.068	1680 2150	130 180	36.1 50.0	3.6 5.8	35.3 56.9	26.2 33.3	46.7 53.8	50	0.80



PUNTO EVO ES RANGE | TECHNICAL DATA FOR REGULATION N° 1254/2014/UE

	UNIT OF MEASURE	ME 100/4" ES	ME 120/5" ES
Supplier's name or trade mark	-	Vortice	Vortice
Specific Energy Consumption class SEC in average climate zone	-	NA	NA
Specific Energy Consumption class SEC average	-	-12.1	-12.3
Specific Energy Consumption class SEC cold	kWh/m ² year	-25.5	-25.6
Specific Energy Consumption class SEC warm	-	-4.5	-4.6
Declared typology	-	RVU-U*	RVU-U*
Type of drive	-	NA	NA
Type of heat recovery system HRS	-	none	none
Thermal efficiency of heat recovery at reference air flow	%	NA*	NA*
Maximum flow rate	m ³ /h	89	175
Electric power input of the fan drive, including any motor control equipment, at maximum flow rate	W	3.5	6.6
Sound power level LWA	LWA [DB(A)]	48	54
Reference flow rate	m ³ /s	0.0173	0.0340
Reference pressure difference	Pa	21	20
SPI	W/(m ³ /h)	0.05297	0.04980
Control factor CTRL	-	1	1
Control typology	-	manual	manual
Maximum internal leakage rates	%	NA	NA
Maximum external leakage rates	%	NA	NA
Mixing rate	-	NA	NA
Position and description of visual filter warning	-	NA	NA
Airflow sensitivity to pressure variations at + 20 Pa and - 20 Pa	-	NA	NA
Indoor/outdoor air tightness	m ³ /h	NA	NA
Annual electricity consumption (AEC)	kWh electricity/year	73	69
AHS average Annual heating saved	-	1397	1397
AHS cold Annual heating saved	kWh primary energy/year	2732	2732
AHS warm Annual heating saved	-	632	632

* RVU-U: Unit Ventilation Residential - Unidirectional

** NRUVU-U: Unit Ventilation Non Residential - Unidirectional

*** MSD: Multi-Speed Drive

NA: Not applicable

DIMENSIONS

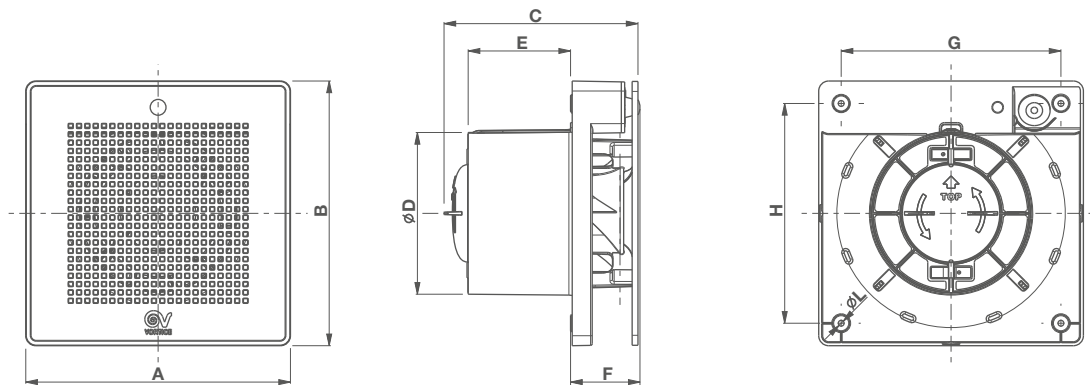

MODELS	A	B	C	ØD	E	F	G	H	ØL
ME 100/4" ES	159	159	132	98	77.5	40.5	132	132	3.5
ME 120/5" ES	179	179	138	118	81	42.5	152	152	3.5

Dimensions (mm)



EXPLODED VIEW

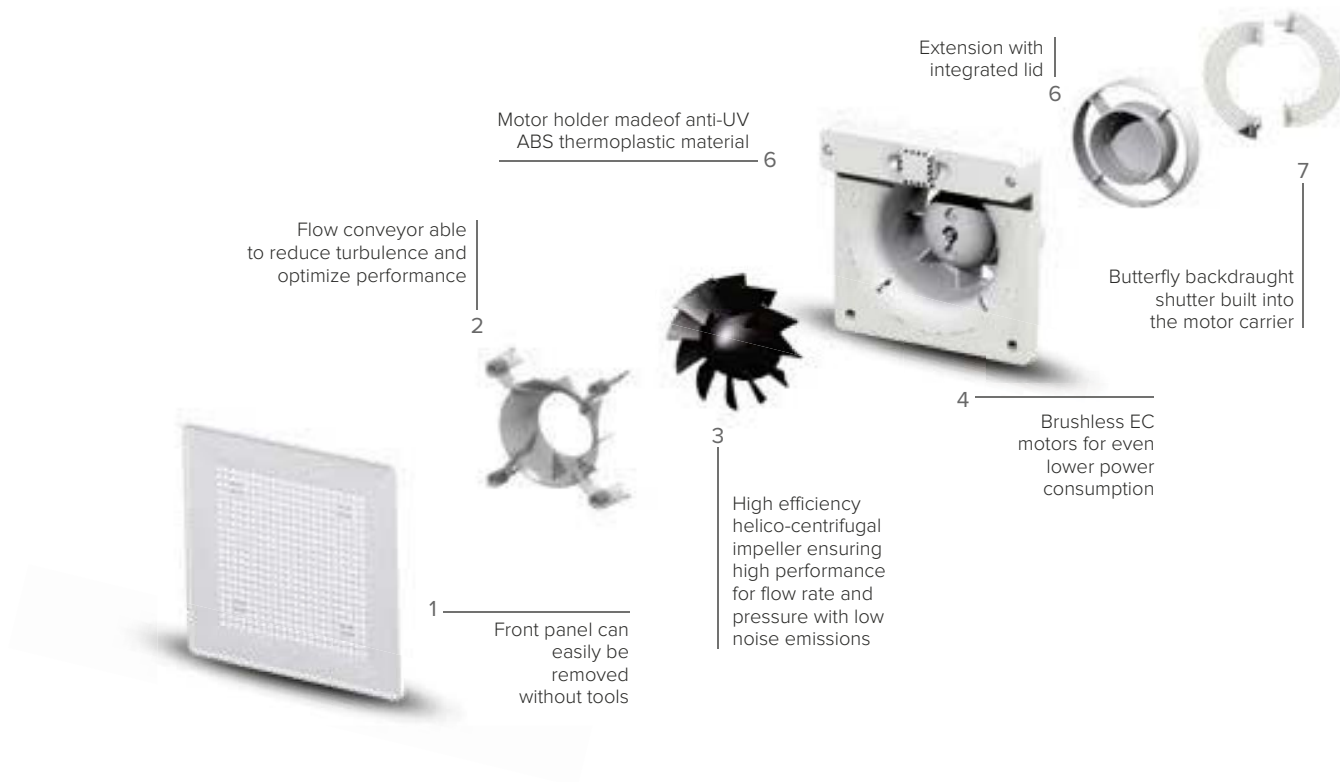

PERFORMANCE CURVES

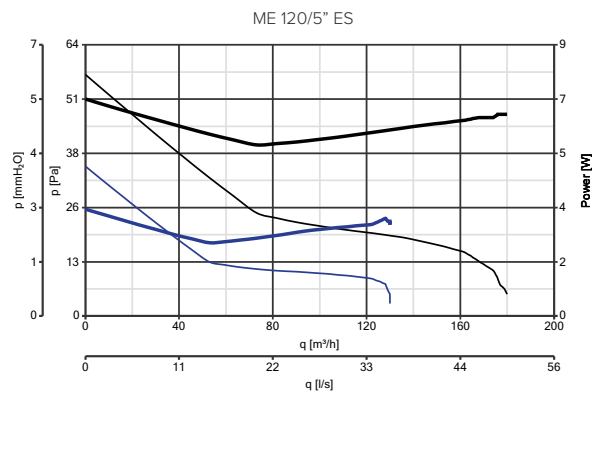
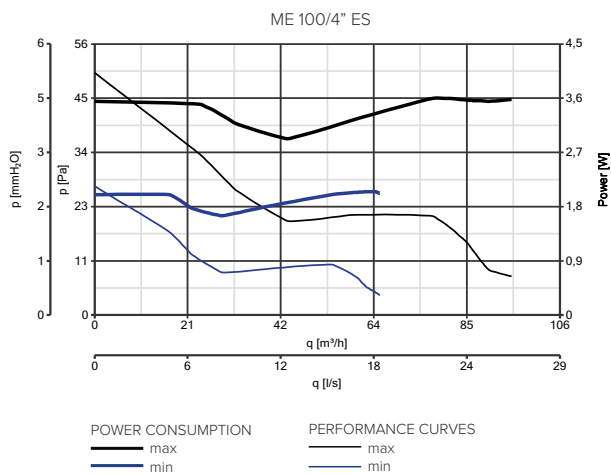



APPLICATIONS

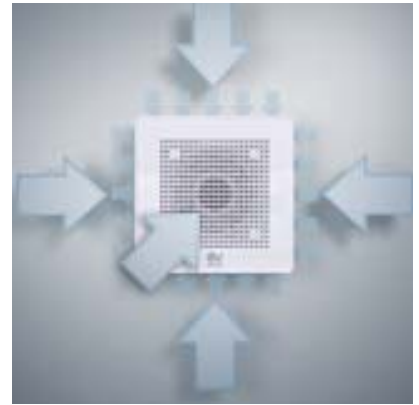



PUNTO EVO GOLD RANGE

Wall axial fans **LONG LIFE 30.000 h**

Wall, ceiling and false-ceiling axial fans, ideal for ventilation in small and medium-size residential and commercial premises, also in the presence of medium length exhaust ducts, characterised by a metallic mirror finish.

Key features

- Silver, gold, copper and black metallic mirror finish
- Very low noise emissions for high comfort of use.
- Very high (IP45) protection rating from dust and water jets, exceeding the requirements of use in Zone 1 bathroom installations.
- 2-speed motors designed to ensure low consumption.
- Sealed non-return valves to prevent unwanted inflows of air and bad odours when the device is switched off.
- Reduced exhaust sleeve depth, compatible with installation immediately upstream of a 90° bend.



Version

- 8 models, with nominal diameter 100 and 120 mm, in silver (White Gold), gold (Yellow Gold), copper (Rose Gold) and black (Black Gold).

Technical features

- Shock-proof plastic resin (ABS) structure with metallic mirror finish obtained through advanced technologies providing attractive and distinctive style, durability and wear resistance.
- Shaded pole motors, heat protected, 2-speed with shafts mounted on ball bearings to guarantee long lasting (at least 30,000 h) continuous service at the maximum plate temperature. Speed adjustment using Vortice accessory devices.
- Helico-centrifugal impellers optimised to ensure high performance, low consumption and low noise emissions, when coupled with underlying flow conditioners.
- Air-tight butterfly valve on the delivery spigots, to prevent unwanted inflows of air and bad odours when the device is switched off.
- Safety certified by third party body (IMQ)
- Protection rating from dust and water: IP45.
- Class of electric isolation: II □ (earthing not required).

RANGE

		PUNTO EVO <i>Gold</i> YELLOW GOLD	PUNTO EVO <i>Gold</i> PINK GOLD	PUNTO EVO <i>Gold</i> BLACK GOLD	PUNTO EVO <i>Gold</i> WHITE GOLD
Diam.					
	BASIC LONG LIFE	11306 ME 100/4" LL	11307 ME 100/4" LL	11308 ME 100/4" LL	11309 ME 100/4" LL
Ø100	TIMER LONG LIFE	11316 ME 100/4" LL T	11317 ME 100/4" LL T	11318 ME 100/4" LL T	11319 ME 100/4" LL T



The **Basic version** is equipped with a 2-speed PCB.



T models equipped with electronic timer for automatic product switch-over from maximum to minimum speed after a pre-fixed period of time after your switch the light off. The delay can be set in the installation phase from 3'-20' (default setting 3'). Alternatively, if the device has been wired to operate at a single speed, the timer determines its delayed stop.



TECHNICAL DATA

MODELS	V~50HZ	W min/max	A min/max	RPM min/max	MAX AIRFLOW		MAX PRESSURE		Lp dB(A)* 3m min/max	Lw dB(A) 3m min/max	MAX °C**	KG
					m³/h min/max	l/s min/max	mmH ₂ O min/max	Pa min/max				
ME 100/4" LL	220-240	5 9	0.039 0.052	1700 2240	65 95	18.1 26.4	2.5 4.7	24.52 46.09	20.8 26.9	41.3 47.4	50	0.60

PUNTO EVO GOLD RANGE | TECHNICAL DATA FOR REGULATION N° 1254/2014/UE

	UNIT OF MEASURE	ME 100/4" LL
Supplier's name or trade mark	-	Vortice
Specific Energy Consumption class SEC in average climate zone	-	NA
Specific Energy Consumption class SEC average		-9.9
Specific Energy Consumption class SEC cold	kWh/m ² year	-23.2
Specific Energy Consumption class SEC warm		-2.2
Declared typology	-	RVU-U*
Type of drive	-	NA*
Type of heat recovery system HRS	-	assente
Thermal efficiency of heat recovery at reference air flow	%	NA*
Maximum flow rate	m ³ /h	93
Electric power input of the fan drive, including any motor control equipment, at maximum flow rate	W	8.1
Sound power level LWA	LWA [DB(A)]	68
Reference flow rate	m ³ /s	0.0181
Reference pressure difference	Pa	22
SPI	W/(m ³ /h)	0.11828
Control factor CTRL	-	1
Control typology	-	manuale
Maximum internal leakage rates	%	NA
Maximum external leakage rates	%	NA
Mixing rate	-	NA
Position and description of visual filter warning	-	NA
Airflow sensitivity to pressure variations at + 20 Pa and - 20 Pa	-	NA
Indoor/outdoor air tightness	m ³ /h	NA
Annual electricity consumption (AEC)	kWh electricity/year	163
AHS average Annual heating saved		1397
AHS cold Annual heating saved	kWh primary energy/year	2732
AHS warm Annual heating saved		632

* RVU-U: Unit Ventilation Residential - Unidirectional

** NRUV-U: Unit Ventilation Non Residential - Unidirectional

*** MSD: Multi-Speed Drive

NA: Not applicable



RESIDENTIAL VENTILATION

PUNTO EVO GOLD RANGE

DIMENSIONS

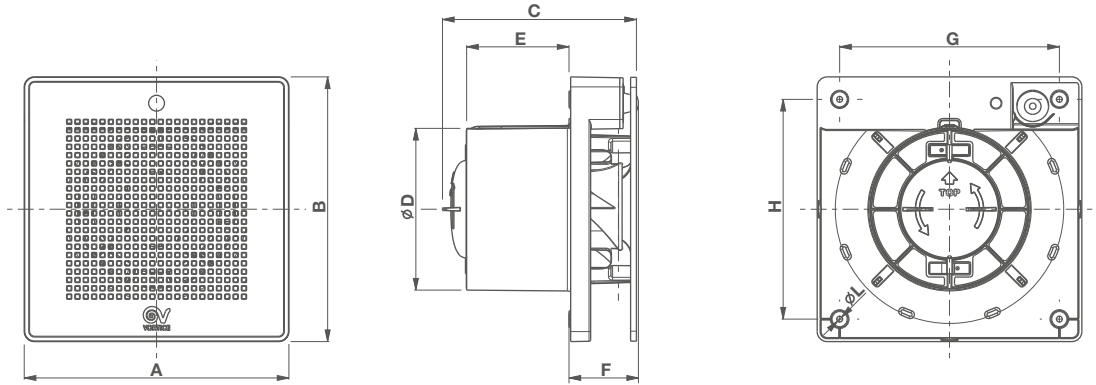

MODELS	A	B	C	Ø D	E	F	G	H	Ø L
ME 100/4" LL	159	159	116.5	98	61.5	40.5	132	132	3.5

Dimensions (mm)

PERFORMANCE CURVES

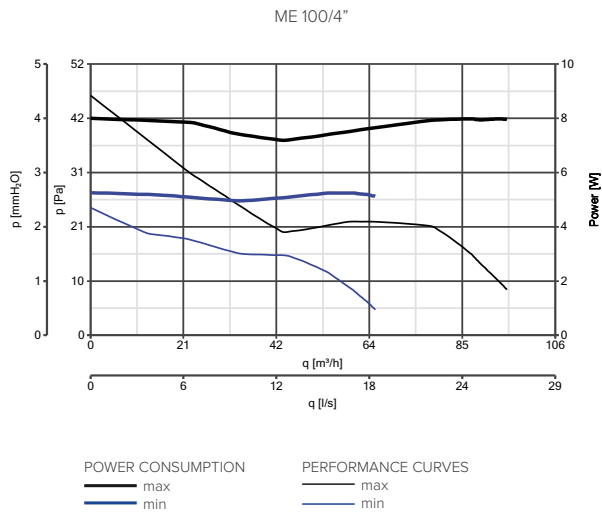



APPLICATIONS

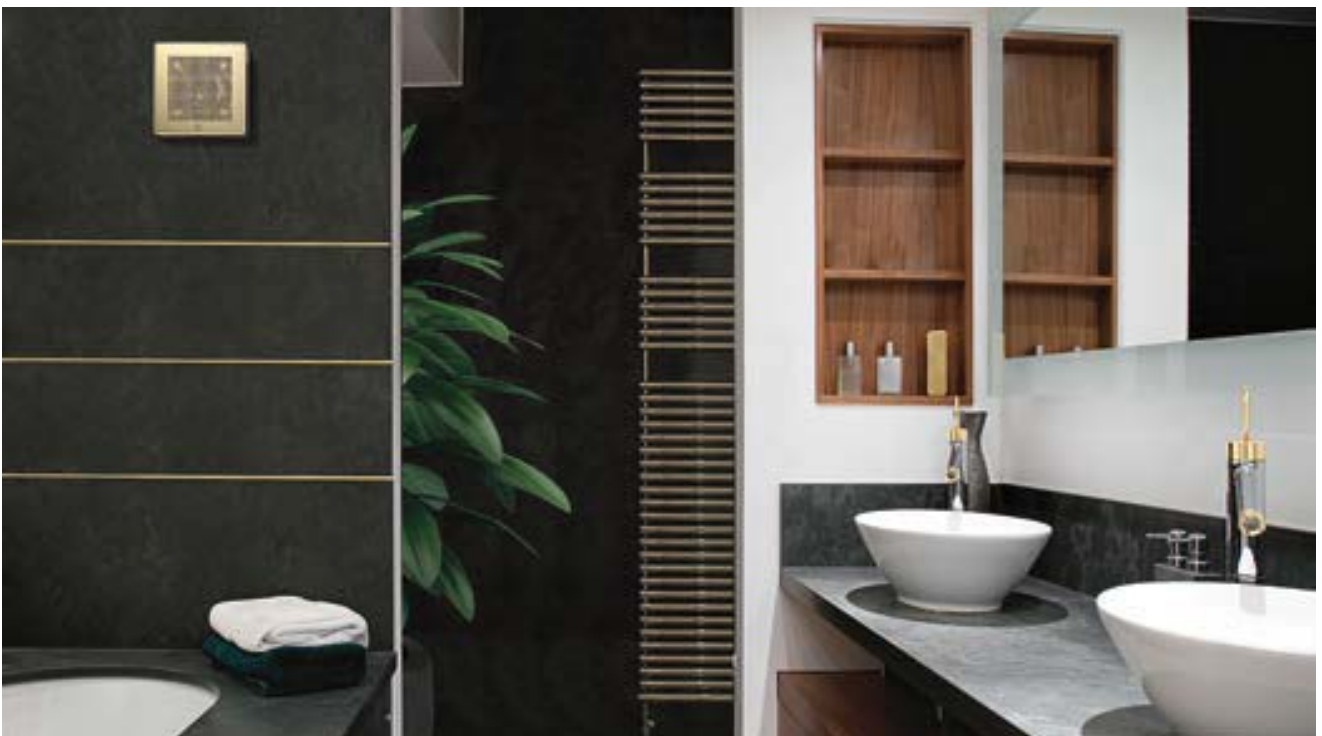



Design: F. Trabucco & Associates



VORTICE VARIO RANGE

Wall/window axial fans **LONG LIFE 80.000 h**

Manual and automatic version unidirectional and reversible axial fans, designed for wall or glass installation in domestic or commercial premises subjected to heavy-duty daily use.

Key features

- Wide range of possible alternative installations (windows, walls, false-ceilings, roofs, dark rooms, etc.) thanks to the optional accessories available.
- Easy, fast installation.
- Elegant, “Intel Design” and “Design Index Adi” award-winning design.
- High protection from water, suitable for use in Zone 1 bathroom installations and in the presence of high relative humidity.

Version

- 7 models, with nominal diameter between 150 and 300 mm, in unidirectional and reversible versions, driven by bushing and bearing motors, with manual and automatic drive closing fins.

Technical features

- White, shock-proof, plastic resin (ABS) panels, prevents ageing caused by exposure to sunlight (“UV resistant”).
- Heat protected motors with shafts mounted on bushings with self-centring and self-lubricating neck to favour low sound emissions, or on ball bearings (LL models) to ensure long lasting (at least 30,000 h) continuous service at the maximum plate temperature. Speed adjustment using Vortice accessory devices. The direction of rotation can be reversed (R models) to perform the double function of extracting stale air and introducing fresh air into the serviced room.
- Axial impellers moulded in plastic resin, resistant to aggressive agents, with saber shaped blades to combine high performance with low noise emissions.
- Exhaust duct closing fins to prevent unwanted inflows of air and bad odours when the device is switched off, automatic drive on A models.
- Possibility of combining with a timer and temperature, relative humidity, smoke and presence sensors (optional).
- Fully compliant with Reg. No. 327/2011/EU.
- Performance and safety certified by third party body (IMQ)
- Protection rating from dust and water: IPX4.
- Class of electric isolation: II □ (earthing not required).

TECHNICAL DATA

MODELS	CODE	V~50/60HZ	W max	A max	RPM max	MAX AIRFLOW m³/h	l/s	Lp dB(A)* 3m max	MAX °C**	KG
VORTICE 150/6" P	12611	220-240	18	0.10	1340	235	65.3	37.5	50	2.07
VORTICE 150/6" AR	12612	220-240	25	0.11	1340 ⁽¹⁾ 2040 ⁽²⁾	235 ⁽¹⁾ 150 ⁽²⁾	65.3 ⁽¹⁾ 41.7 ⁽²⁾	37.5	50	2.07
VORTICE 150/6" AR LL S	14615	220-240	35	0.17	2110 ⁽²⁾ 2520 ⁽¹⁾	380 ⁽²⁾ 215 ⁽¹⁾	105.6 ⁽²⁾ 59.7 ⁽¹⁾	49.6	50	2.07
VORTICE 150/6" P LL S	12614	220-240	32	0.16	2110	380	105.6	46.9	50	2.07
VORTICE 230/9" P	12451	220-240	22	0.10	790	480	133	35.6	50	3.45
VORTICE 230/9" AR	12452	220-240	26	0.13	790 ⁽¹⁾ 1080 ⁽²⁾	480 ⁽¹⁾ 310 ⁽²⁾	133 ⁽¹⁾ 86 ⁽²⁾	35.6	50	3.45
VORTICE 230/9" P LL S	12454	220-240	32 (50 Hz) 38 (60 Hz)	0.18	1200	700	194.4	43.6	50	3.45
VORTICE 230/9" AR LL S	12455	220-240	35 (50 Hz) 40 (60 Hz)	0.19	1200 ⁽¹⁾ 1300 ⁽²⁾	700 ⁽¹⁾ 370 ⁽²⁾	194.4 ⁽¹⁾ 102.8 ⁽²⁾	43.6	50	3.45
VORTICE 300/12" AR	12412	220-240	45	0.21	840 ⁽¹⁾ 1085 ⁽²⁾	1050 ⁽¹⁾ 700 ⁽²⁾	292 ⁽¹⁾ 194.4 ⁽²⁾	40.2	50 (50 Hz) 40 (60 Hz)	6.13
VORTICE 300/12" AR LL S	12415	220-240	75 (50 Hz) 90 (60 Hz)	0.41	1215 ⁽¹⁾ 1280 ⁽²⁾	1650 ⁽¹⁾ 920 ⁽²⁾	458.3 ⁽¹⁾ 255.6 ⁽²⁾	53.6	50 (50 Hz) 40 (60 Hz)	6.13



DIMENSIONS

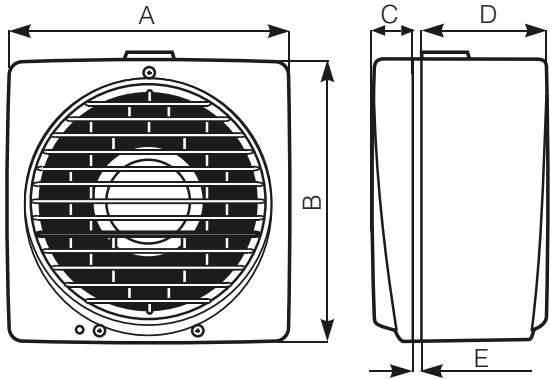

MODELS	A	B	C	D	E MIN/MAX	HOLE DIA Ø
VORTICE 150/6"	215	218	31	97.5	2/38	185÷190
VORTICE 230/9"	294	297	31	130	2/38	257÷262
VORTICE 300/12"	390	393	31	147	2/38	324÷329

Dimensions (mm)

PERFORMANCE CURVES

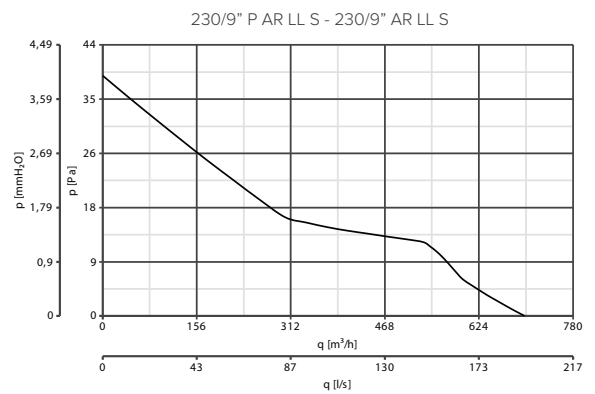
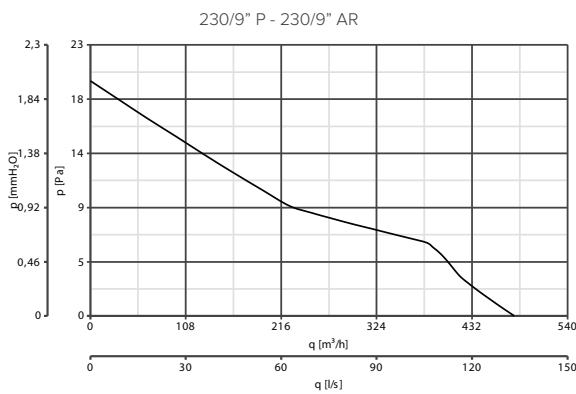
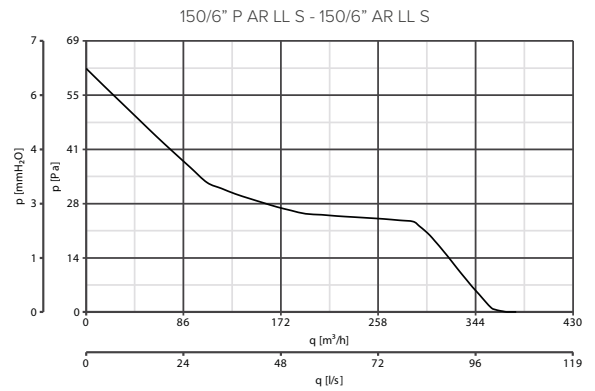
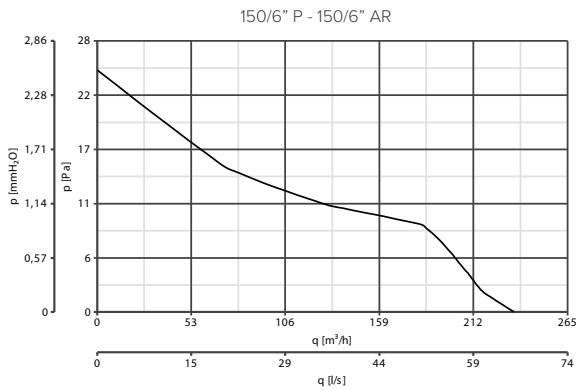

— Power consumption — Delivery



RESIDENTIAL VENTILATION



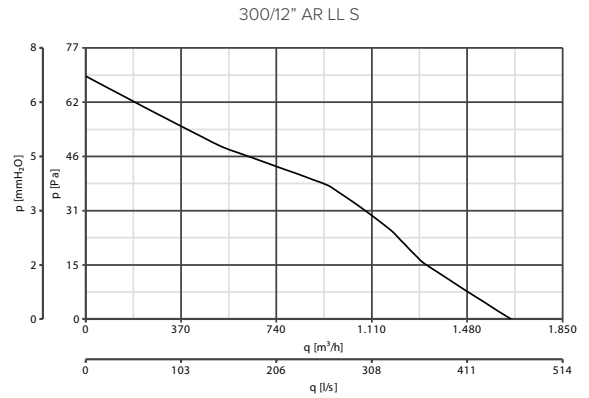
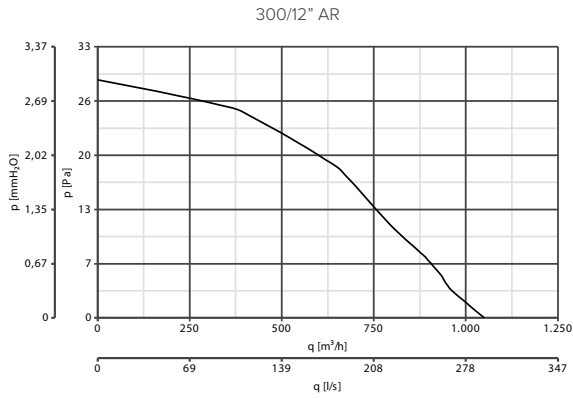

VORTICE VARIO RANGE

PERFORMANCE CURVES







— Power consumption — Delivery

CONTROLLER



MODELS	DESCRIPTION	CODE	PRODUCTS
	CR5N - Reversible 5 speeds controller	12941	All products (not for code 12611 - 12451)
	CREN - Reversible 5 speeds controller	12944	All products (not for code 12611 - 12451)
	C TEMP - Environmental sensor for temperature	12992	All products (not for code 12611 - 12451)
	C SMOKE - Environmental sensor for air quality	12993	All products (not for code 12611 - 12451)
	C HCS - Environmental sensor for humidity	12994	All products (not for code 12611 - 12451)
	C PIR - Passive infrared sensor	12998	All products (not for code 12611 - 12451)
	C TIMER - Adjustable over-run timer	12999	All products (not for code 12611 - 12451)

ACCESSORIES ON REQUEST

MODELS	DESCRIPTION	CODE	PRODUCTS
	150/6"	13021	12611 - 12612 - 12615 - 12614
	230/9"	13022	12451 - 12452 - 12454 - 12455
	300/12"	13023	12412 - 12415
	150/6"	13024	12611 - 12612 - 12615 - 12614
	230/9"	13025	12451 - 12452 - 12455
	300/12"	13026	12412 - 12415
	150/6"	13027	12611 - 12612 - 12615 - 12614
	230/9"	13028	12451 - 12452 - 12454 - 12455
	300/12"	13029	12412 - 12415
	KIT MU - Wall mounting kit with rods	13018	12611 - 12612 - 12451 - 12452 - 12455 12412 - 12415



ACCESSORIES ON REQUEST

MODELS	DESCRIPTION	CODE	PRODUCTS
	KIT TE - Roof cowl/wind baffle kit	150/6"	12611 - 12612 - 12615 - 12614
		230/9"	12451 - 12452 - 12454 - 12455
		300/12"	12412 - 12415
	KIT SA - Darkroom cowl kit	13004	12451 - 12452 - 12455 - 12613 - 12616 12653 - 12456 - 12413 - 12416



SINGLE AND DOUBLE-GLAZED WINDOW

Models	Code	Kit required (code)	thickness min/max
150/6" P	12611		
150/6" AR	12612		
150/6" P LL S	12614		
150/6" AR LL S	12615		
230/9" P	12451	none	2÷38
230/9" AR	12452		
230/9" P LL S	12454		
230/9" AR LL S	12455		
300/12" AR	12412		
300/12" AR LL S	12415		



WINDOW/PANEL MOUNTING WITH EXTERNAL COWL AS A WIND BAFFLE

Models	Code	Kit required (code)
150/6" P	12611	13001
150/6" AR	12612	
150/6" P LL S	12614	
150/6" AR LL S	12615	
230/9" P	12451	13002
230/9" AR	12452	
230/9" P LL S	12454	
230/9" AR LL S	12455	
300/12" AR	12412	13003
300/12" AR LL S	12415	



KIT VV - DOUBLE-GLAZED (OPENING) WINDOW

Models	Code	Kit required (code)	thickness min/max
150/6" P	12611	13021	
150/6" AR	12612		
150/6" P LL S	12614		
150/6" AR LL S	12615		
230/9" P	12451	13022	30÷43
230/9" AR	12452		
230/9" AR LL S	12455		
230/9" P LL S	12454		
300/12" AR	12412	13023	
300/12" AR LL S	12415		



WALL MOUNTING FOR REMOTE APPLICATION*

Models	Code	Kit required (code)
150/6" AR	12612	13003 + 13018 + 2 items 13027
150/6" AR LL S	16615	
230/9" AR	12452	13002 + 13018 + 2 items 13028
230/9" AR LL S	12455	
300/12" AR	12412	13003 + 13018 + 2 items 13029
300/12" AR LL S	12611	

* duct not included



KIT FF - DOUBLE (OPENING) WINDOW SECONDARY-GLAZED

Models	Code	Kit required (code)	thickness min/max
150/6" P	12611	13024	
150/6" AR	12612		
150/6" P LL S	12614		
150/6" AR LL S	12615		
230/9" P	12451	13025	230÷300
230/9" AR	12452		
230/9" AR LL S	12455		
230/9" P LL S	12454		
300/12" AR	12412	13026	
300/12" AR LL S	12415		

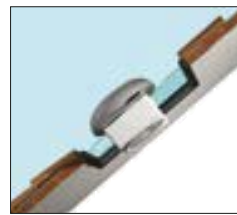

PANEL/WALL MOUNTING WITH DARKROOM COWL

Models	Code	Kit required (code)
230/9" P	12451	glass = 13004 wall = 13004 + 13018
230/9" P LL S	12454	
230/9" AR	12452	
230/9" AR LL S	12455	

KIT TE - ROOF COWL/WIND BAFFLE KIT

Models	Code	Kit required (code)	
150/6" P	12612	13001	
150/6" P LL S	12614		
150/6" AR LL S	12615		
230/9" AR	12452		
230/9" AR LL S	12455	13002	
230/9" P LL S	12454		
300/12" AR	12412		13003
300/12" AR LL S	12415		



KIT MU - WALL MOUNTING

Models	Code	Kit required (code)	thickness min/max
150/6" P	12611		
150/6" AR	12612		
150/6" P LL S	12614		
150/6" AR LL S	12615		
230/9" P	12451	13018	300
230/9" AR	12452		
230/9" AR LL S	12455		
230/9" P LL S	12454		
300/12" AR	12412		
300/12" AR LL S	12415		



ROOF MOUNTING WITH EXTERNAL COWL AS A WIND BAFFLE

Models	Code	Kit required (code)	thickness min/max
150/6" P	12611	13001 + 13018	
150/6" AR	12612		
150/6" P LL S	12614		
150/6" AR LL S	12615		
230/9" P	12451	13002 + 13018	300
230/9" AR	12452		
230/9" AR LL S	12455		
230/9" P LL S	12454		
300/12" AR	12412	13003 + 13018	
300/12" AR LL S	12415		



VORTICE VARIO I RANGE

Flush mounted axial fans **LONG LIFE 30.000 h**

Manual and automatic version unidirectional and reversible axial fans, designed for recessed installation in domestic or commercial premises subjected to heavy-duty daily use.

Key features

- Wide range of possible alternative installations (recessed, recessed with remote exhaust, recessed with remote exhaust from roof, false-ceiling, etc.) thanks to the optional accessories available.
- Easy, fast installation.
- Elegant, "Intel Design" and "Design Index Adi" award-winning design.
- High protection from water, suitable for use in Zone 1 bathroom installations and in the presence of high relative humidity.

Version

3 models, with nominal diameter between 150 and 300 mm, reversible, driven by bearing motors, with automatic drive closing fins.

Technical features

- White, shock-proof, plastic resin (ABS) panels, prevents ageing caused by exposure to sunlight ("UV resistant").
- Black internal casings, moulded in shock-proof plastic resin and resistant to aggressive agents.
- Heat protected motors with shafts mounted on ball bearings to guarantee long lasting continuous service (at least 30,000 h) at the maximum plate temperature. Speed adjustment using Vortice accessory devices. The direction of rotation can be reversed to perform the double function of extracting stale air and introducing fresh air into the serviced room.
- Axial impellers moulded in plastic resin, resistant to aggressive agents, with saber shaped blades to combine high performance with low noise emissions.
- Automatic drive exhaust duct closing fins to prevent unwanted inflows of air and bad odours when the device is switched off.
- Possibility of combining with a timer and temperature, relative humidity, smoke and presence sensors (optional).
- Fully compliant with Reg. No. 327/2011/EU.
- Performance and safety certified by third party body (IMQ)
- Protection rating from dust and water: IPX4.
- Class of electric isolation: II □ (earthing not required).

Design: F. Trabucco & Associates



TECHNICAL DATA

MODELS	CODE	V~50/60HZ	W max	A max	RPM max	MAX AIRFLOW m ³ /h	l/s	Lp dB(A)* 3m max	MAX °C**	KG
VORTICE 150/6" ARI	12613	220-240	25	0.11	1330 ⁽¹⁾ 1880 ⁽²⁾	220 ⁽¹⁾ 130 ⁽²⁾	61.1 ⁽¹⁾ 36.1 ⁽²⁾	38.2	50	2.52
VORTICE 150/6" ARI LL S	12616	220-240	35	0.17	2080 ⁽¹⁾ 2460 ⁽²⁾	350 ⁽¹⁾ 200 ⁽²⁾	97.2 ⁽¹⁾ 55.6 ⁽²⁾	49.1	50	2.52
VORTICE 230/9" ARI	12453	220-240	26	0.13	810 ⁽¹⁾ 1080 ⁽²⁾	450 ⁽¹⁾ 300 ⁽²⁾	125 ⁽¹⁾ 83.3 ⁽²⁾	35.7	50	3.88
VORTICE 230/9" ARI LL S	12456	220-240	35 (50 Hz) 40 (60 Hz)	0.19	1160 ⁽¹⁾ 1260 ⁽²⁾	680 ⁽¹⁾ 350 ⁽²⁾	188.9 ⁽¹⁾ 97.2 ⁽²⁾	45.3	50	3.88
VORTICE 300/12" ARI	12413	220-240	45	0.21	850 ⁽¹⁾ 1150 ⁽²⁾	1200 ⁽¹⁾ 850 ⁽²⁾	333.3 ⁽¹⁾ 236.1 ⁽²⁾	40.7	50 (50 Hz) 40 (60 Hz)	7.20
VORTICE 300/12" ARI LL S	12416	220-240	75 (50 Hz) 90 (60 Hz)	0.41	1230 ⁽¹⁾ 1310 ⁽²⁾	1750 ⁽¹⁾ 1000 ⁽²⁾	486.1 ⁽¹⁾ 277.7 ⁽²⁾	53.5	50 (50 Hz) 40 (60 Hz)	7.20

⁽¹⁾ Intake - ⁽²⁾ Extract

Legend: P= Pull Cord, A= Automatic, R= Reversible, LL= Long Life, S= Performance boost.



DIMENSIONS

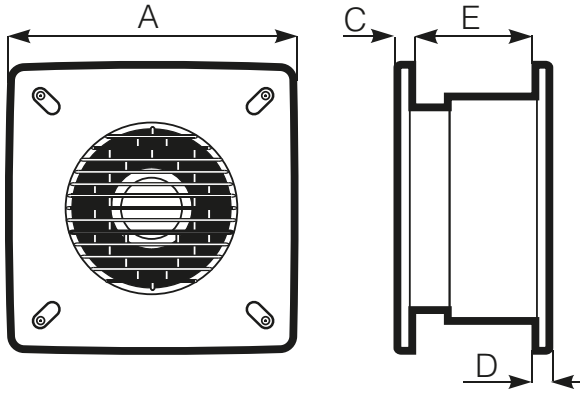

PRODOTTI	A	B	C	D	HOLE DIA
VORTICE 150/6" ARI	300	9.5	10.5	135	260÷265
VORTICE 230/9" ARI	400	10	11.0	180	335÷340
VORTICE 300/12"	495	10.5	11.5	210	435÷440

Quote in mm

PERFORMANCE CURVES

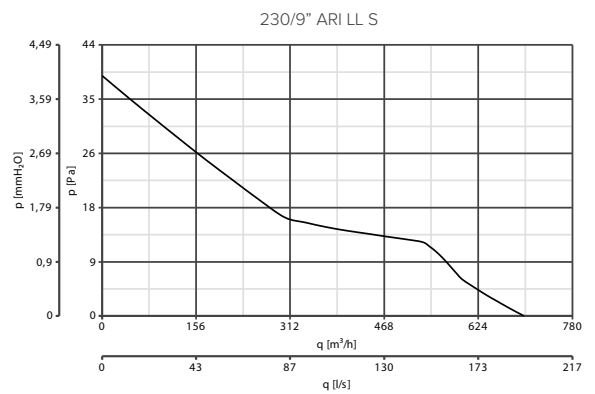
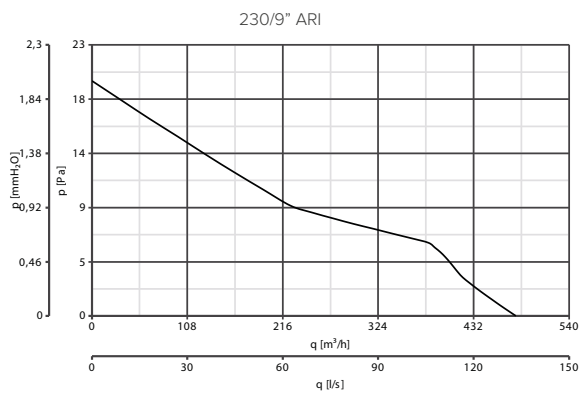
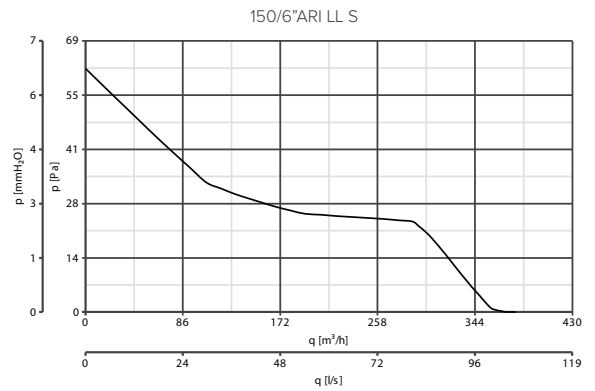
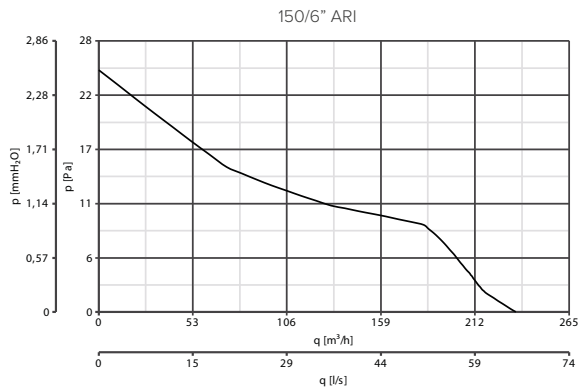

— Power consumption — Delivery



RESIDENTIAL VENTILATION



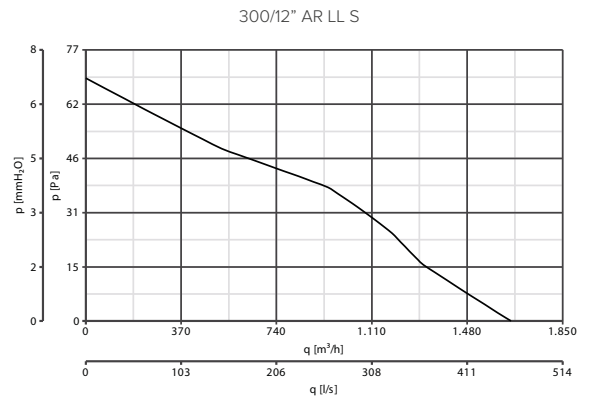
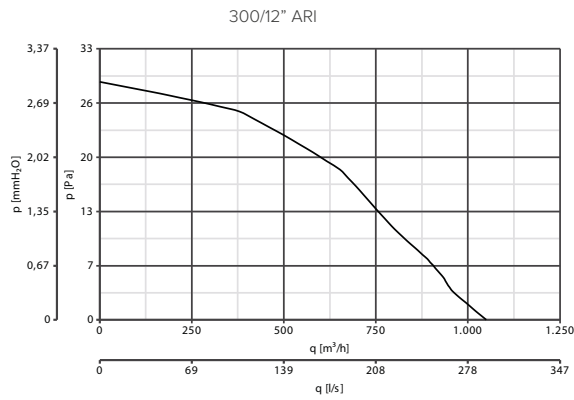

VORTICE VARIO I RANGE

PERFORMANCE CURVES





— Power consumption — Delivery

CONTROLLER

MODELS	DESCRIPTION	CODE	PRODUCT
	CR5N - Reversible 5 speeds controller	12941	All products
	CREN - Reversible 5 speeds controller	12944	All products
	C TEMP - Environmental sensor for temperature	12992	All products
	C SMOKE - Environmental sensor for air quality	12993	All products
	C HCS - Environmental seonsor for humidity	12994	All products
	C PIR - Passive infrared sensor	12998	All products
	C TIMER - Adjustable over-run timer	12999	All products

ACCESSORIES ON REQUEST

MODELS	DESCRIPTION	CODE	PRODUCT	
	KIT ML - Deep wall installation kit	150/6"	13015	12616 - 12613
		230/9"	13016	12456 - 12653
		300/12"	13017	12416 - 12413
	KIT TC - Spigot plate remote application	150/6"	13027	12616 - 12613
		230/9"	13028	12456 - 12653
		300/12"	13029	12416 - 12413
	KIT SO - Ceiling, false ceiling and panel kit	150/6" 230/9"	13012	12616 - 12456 - 12613 - 12653
		300/12"	13014	12413 - 12416



ACCESSORIES ON REQUEST



BUILT-IN WALL MOUNTING

Models	Code	Kit required (code)	thickness
150/6" ARI LL S	12616	none	135
150/6" ARI	12613		
230/9" ARI LL S	12456	none	180
230/9" ARI	12453		
300/12" ARI LL S	12416	none	210
300/12" ARI	12413		

BUILT-IN DEEP WALL MOUNTING

Models	Code	Kit required (code)	thickness min/max
150/6" ARI LL S	12616	13015	260-460
150/6" ARI	12613		
230/9" ARI LL S	12456	13016	320-500
230/9" ARI	12453		
300/12" ARI LL S	12416	13017	375-515
300/12" ARI	12413		



BUILT-IN PANEL, CEILING AND FALSE CEILING MOUNTING*

Models	Code	Kit required (code)
150/6" ARI LL S	12616	13012
150/6" ARI	12613	
230/9" ARI LL S	12456	13014
230/9" ARI	12453	
300/12" ARI LL S	12616	13014
300/12" ARI LL S	12616	

* duct not included

TELESCOPIC FRAME FOR WALL MOUNTED MODELS

This frame is made of expanded polystyrene and facilitates wall mounting of the Vortice Vario series. Accessory included.

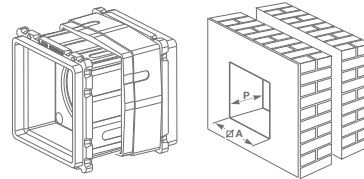

MODEL	∅ A	P (MIN)	P (MAX)
150/6"	325	220	330
230/9"	400	220	330
300/12"	500	220	330

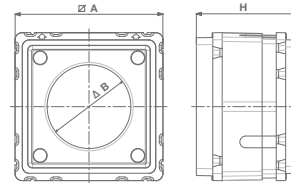

MODEL	A	∅B	H
3,217 MM	325	180	205-330
KIT IN 230/9"	400	260	205-330
KIT IN 300/12"	500	305	205-330

Number of required kits	150/6" AR Code 12612	150/6" ARI LL S Code 12615	150/6" P Code 12611	150/6" PLL S Code 12614	230/9" AR Code 12452	230/9" ARI LL S Code 12455	230/9" P Code 12451	230/9" PLL S Code 12454	300/12" AR Code 12412	300/12" ARI LL S Code 12415	150/6" ARI Code 12613	150/6" ARI LL S Code 12616	230/9" ARI Code 12653	230/9" ARI LL S Code 12456	300/12" ARI Code 12413	300/12" ARI LL S Code 12416
-------------------------	----------------------	----------------------------	---------------------	-------------------------	----------------------	----------------------------	---------------------	-------------------------	-----------------------	-----------------------------	-----------------------	----------------------------	-----------------------	----------------------------	------------------------	-----------------------------

SINGLE-GLAZED WINDOW

Wall	1	13018	13018	13018	13018	13018	13018	13018	13018	13018	13018	13018	13018	13018	13018	13018
Double-glazed (opening window)	1	13021	13021	13021	13021	13022	13022	13022	13022	13023	13023					
Double (opening) window secondary-glazing	1	13024	13024	13024	13024	13025	13025	13025	13025	13026	13026					
Window-mounted with darkroom cowl	1					13004	13004	13004	13004							
Window / panel mounted with external cowl	1	13001	13001	13001	13001	13002	13002	13002	13002	13003	13003					
Roof application	1	13001	13001	13001	13001	13002	13002	13002	13002	13003	13003					
Wall-mounted with external cowl	2	13001 13018	13001 13018	13001 13018	13001 13018	13002 13018	13002 13018	13002 13018	13002 13018	13003 13018	13003 13018					
Wall-mounted for remote application (duct not included)	1	13001 13018 13027x2	13001 13018 13027x2	13001 13018 13027x2	13001 13018 13027x2	13002 13018 13027x2	13002 13018 13027x2	13002 13018 13027x2	13002 13018 13027x2	13003 13018 13027x2	13003 13018 13027x2					

BUILT-IN WALL MOUNTED

Thin wall mounted for remote application (duct not included)	3	13001 13012 13018 13027	13001 13012 13018 13027	13001 13012 13018 13027	13001 13012 13018 13027	13002 13012 13018 13028	13002 13012 13018 13028	13002 13012 13018 13028	13002 13012 13018 13028	13003 13014 13018 13029	13003 13014 13018 13029					
Panel-mounted with darkroom cowl	1					13004	13004	13004	13004							
Wall-mounted with darkroom cowl	2					13018 13004	13018 13004	13018 13004	13018 13004							
Built-in deep wall mounted	1											13015	13015	13016	13016	13017
Panel - Ceiling - False ceiling	1											13012	13012	13012	13012	13014
Roof-mounted for remote application (duct not included)	3											13001 13027 13012	13001 13027 13012	13002 13028 13012	13002 13028 13012	13003 13029 13014
Built-in wall mounted for remote application (duct not included)	3											13012 13015 13027	13012 13015 13027	13012 13016 13028	13012 13016 13028	13014 13017 13029



Design: F. Trabucco - M. Vecchi



K RANGE

In-line centrifugal fans for kitchen cabinet

One or two-speed centrifugal duct fans, ideal for ventilating small and medium-size residential and commercial premises. The AXIAL K model is designed for suction in-line with the exhaust, while the ANGOL K model instead allows for 90° exhaust with respect to suction.

Key features

- Excellent performance/price ratio
- Easy, fast installation.
- ANGOL K equipped with a 2-speed motor to adapt the performance provided to the actual current needs.

Version

2 models, both the nominal diameter 100 mm, designed for in-line exhaust or 90° rotated exhaust with respect to the suction.

Technical features

- White, shock-proof, plastic resin casings prevent ageing caused by exposure to sunlight ("UV resistant"). Protective grilles integrated into the air inlets
- Heat-protected motors, two-speed in ANGOL K, with shafts mounted on bushings with self-centring and self-lubricating neck to keep sound emissions down and guarantee regular product operation for durations suitable to typical applications. Speed adjustment using Vortice accessory devices.
- Centrifugal impellers moulded in plastic resin, resistant to aggressive agents, with optimised profile blades to combine high performance with considerable flow rate levels
- Performance and safety certified by third party body (IMQ)
- Class of electric isolation: II □ (earthing not required).



Awards
1991 Italian Golden Compass
honor award

TECHNICAL DATA

MODELS	CODE	V~50HZ	W min/max	A min/max	RPM min/max	MAX AIRFLOW		MAX PRESSURE		Lp dB(A)* 3m min/max	MAX °C**	KG
						m³/h min/max	l/s min/max	mmH₂O min/max	Pa min/max			
ANGOL K	10204	220-240	29 35	0.12 0.16	1410 2180	86 140	23.9 38.9	13.5 17	132 157	33 43	40	1.27
AXIAL K	10904	220-240	27	0.13	2560	135	37.5	17	167	41	40	1.20

* Data refers to both speeds. Measurement taken in front of the intake port with outlet connected and unobstructed extraction. Conforms with ISO 3744 for noise and pressure levels.



K RANGE | TECHNICAL DATA FOR REGULATION N° 1254/2014/UE

	UNIT OF MEASURE	ANGOL K	AXIAL K
Supplier's name or trade mark	-	Vortice	Vortice
Specific Energy Consumption class SEC in average climate zone	-	NA	NA
Specific Energy Consumption class SEC average	-	-2.2	-1.8
Specific Energy Consumption class SEC cold	kWh/m ² year	-10.9	-10.5
Specific Energy Consumption class SEC warm	-	10.1	10.5
Declared typology	-	RVU-U*	RVU-U*
Type of drive	-	NA	NA
Type of heat recovery system HRS	-	none	none
Thermal efficiency of heat recovery at reference air flow	%	NA	NA
Maximum flow rate	m ³ /h	75	78
Electric power input of the fan drive, including any motor control equipment, at maximum flow rate	W	29.2	27.0
Sound power level LWA	LWA [DB(A)]	62	64
Reference flow rate	m ³ /s	0.0146	0.0152
Reference pressure difference	Pa	82	129
SPI	W/(m ³ /h)	0.47619	0.48901
Control factor CTRL	-	1	1
Control typology	-	manual	manual
Maximum internal leakage rates	%	NA	NA
Maximum external leakage rates	%	NA	NA
Mixing rate	-	NA	NA
Position and description of visual filter warning	-	NA	NA
Airflow sensitivity to pressure variations at + 20 Pa and - 20 Pa	-	NA	NA
Indoor/outdoor air tightness	m ³ /h	NA	NA
Annual electricity consumption (AEC)	kWh electricity/year	597	613
AHS average Annual heating saved	-	1715	1715
AHS cold Annual heating saved	kWh primary energy/year	2732	2732
AHS warm Annual heating saved	-	632	632

* RVU-U: Unit Ventilation Residential - Unidirectional

** NRUVU-U: Unit Ventilation Non Residential - Unidirectional

*** MSD: Multi-Speed Drive

NA: Not applicable

DIMENSIONS

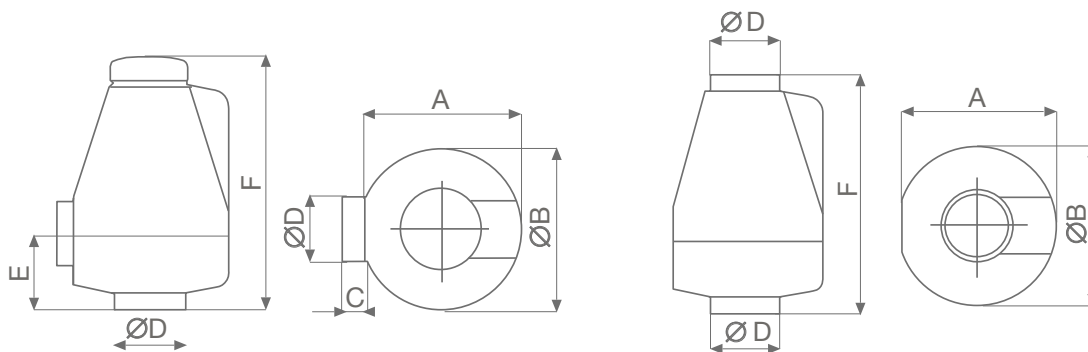

MODELS	øA	øB	C	øD	E	F
ANGOL K	168	176	25	97	93	281
AXIAL K	168	176	-	97	-	270

Dimensions (mm)



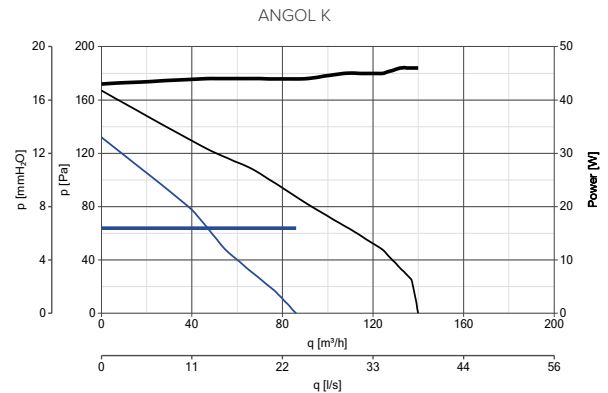
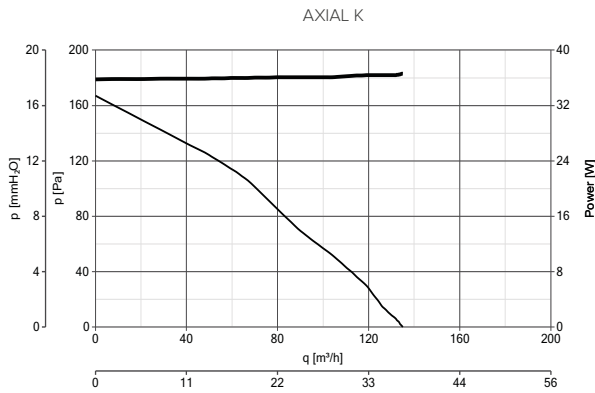

PERFORMANCE CURVES





POWER CONSUMPTION
 — max
 — min

PERFORMANCE CURVES
 — max
 — min

CONTROLLER

MODELS	DESCRIPTION	CODE	PRODUCT
	C 1.5 - Electronic speed controller 1.5 A	12966	ALL PRODUCTS
	SCNRB - Electronic speed controller built-in	12971	ALL PRODUCTS
	SCB KIT - Built-in controller adaptor for C 1.5	22481	12966

ACCESSORIES ON REQUEST

MODELS	DESCRIPTION	CODE	PRODUCT	
	AIR DEFLECTOR	100/4	22310	ALL PRODUCTS
	CA MU - Galvanized sheet-metal brackets		22674	ALL PRODUCTS



APPLICATIONS

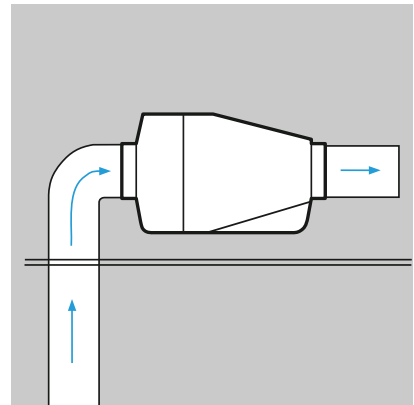
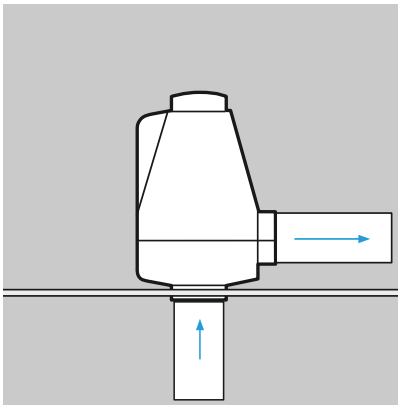
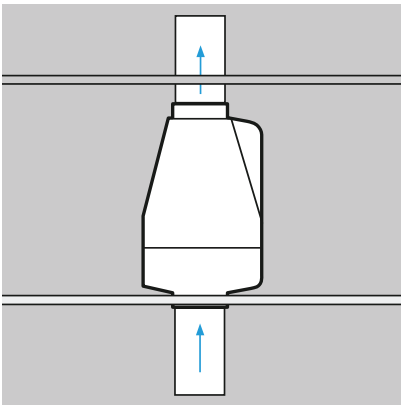



VORTEX® RANGE

Cooker hoods



Domestic extractor hoods with 120 mm duct exhaust, available in four versions differing by width (60 cm or 90 cm) and by white or stainless steel finish.

Key features

- Very low noise emissions
- High performance.
- Suitable for replacing pre-existing hoods.

Version

4 single-motor models, available in two highly requested standard measurements 60 and 90 cm and in 2 colours: white and stainless steel.



Technical features

- The hoods are supplied in the extractor version, but can be converted in the filtration version using suitable supplied accessories.
- Power and quiet: the low noise level at first speed is ideal for anyone who has to spend a lot of time in the kitchen preparing food.
- Sturdy: the steel sheet structure is painted with scratch-resistant powder and in stainless steel version. The extractor unit, motor mounting and fan impeller are made of self-extinguishing resin. Insulation class B motor equipped with thermal overload limiter.
- Commands: Choice between three extraction speeds. A light indicates the selected speed.
- Excellent light distribution: equipped with 40W lamp so as to light up foods without altering their colour, and diffusers providing best possible illumination of the cook top. Movable glass visor.
- Extremely effective grease filter in special suction fabric dishwasher safe.
- Supplied: 100 mm adapter for duct exhaust, flange for duct exhaust is 120 mm with butterfly valve against air re-entry, cap, great filter for suction hood, activated carbon filter for exhaust hood transformation, power cord with European plug, screws and dowels for installation.
- Performance and safety certified by third party body (CE).
- Protection rating from dust and water: IPX4.

TECHNICAL DATA

MODELS	CODE	COLOUR	V~50HZ	W max	MAX AIRFLOW		MAX PRESSURE		Lp dB(A) 3m max	KG
					m³/h min/max	l/s min/max	mmH₂O min/max	Pa min/max		
VORTEX 60-B	20021	WHITE	230-240	120 +40	120 250	33 69	12 21	118 210	37 56	8.5
VORTEX 60-I	20022	INOX	230-240	120 +40	120 250	33 69	12 21	118 210	37 56	8.5
VORTEX 90-B	20023	WHITE	230-240	120 +40	120 250	33 69	12 21	118 210	37 56	11.0
VORTEX 90-I	20024	INOXW	230-240	120 +40	120 250	33 69	12 21	118 210	37 56	11.0



VORTEX RANGE | TECHNICAL DATA FOR REGULATION N° 1254/2014/UE

	UNIT OF MEASURE	VORTEX 60	VORTEX 90
Supplier's name or trade mark	-	Vortice	Vortice
Annual energy consumption (AEC _{hood})	kWh/a	86.3	86.3
Energy efficiency class.	-	E	E
Fluid dynamic efficiency	-	5.3	5.3
Fluid dynamic efficiency class.	-	F	F
Light efficiency	lux/W	2.0	2.0
Lighting efficiency class.	-	G	G
Grease filtering efficiency	%	64.1	64.1
Grease filtering efficiency class.	-	E	E
Air flow at minimum speed	m ³ /h	110	110
Air flow at maximum speed in normal use	m ³ /h	235	235
Air flow at intensive or boost setting	m ³ /h	-	-
Airborne acoustical A-weighted sound power emissions at minimum speed	dB(A) re 1pW	51	51
Airborne acoustical A-weighted sound power emissions at maximum speed in normal use	dB(A) re 1pW	69	69
Airborne acoustical A-weighted sound power emissions at intensive or boost setting	dB(A) re 1pW	-	-
Power consumption in off mode (P _o)	W	-	-
Power consumption in standby mode (P _s)	W	0.00	0.00
Time increase factor (f)	-	1.8	1.8
Energy efficiency index (EE _{hood})	-	100.6	100.6
Measured air flow rate at best efficiency point (QBEP)	m ³ /h	122.2	122.2
Measured air pressure at best efficiency point (PBEP)	Pa	155	155
Maximum air flow (Q _{max})	m ³ /h	235.0	235.0
Measured electric power input at best efficiency point (WBEP)	m ³ /h	100.2	100.2
Nominal power of the lighting system (W _L)	W	28.0	28.0
Average illumination of the lighting system on the cooking surface (E _{middle})	lux	57	57

DIMENSIONS

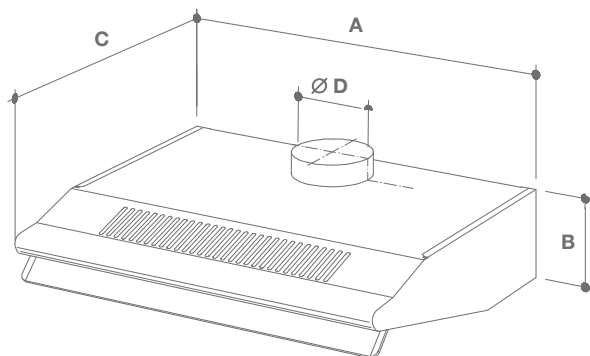

MODELS	A	B	C	ØD
VORTEX 60	600	140	495	123
VORTEX 90	900	140	495	123

Dimensions (mm)



RESIDENTIAL VENTILATION

VORTEX® RANGE

ACCESSORIES ON REQUEST

MODELS	DESCRIPTION	CODE	PRODUCT
	T - EXTRACTION KIT	22101	ALL PRODUCT
	VX - CB - Telescopic chimney white	22116	20021 - 20023
	VX - CI - Telescopic chimney stainless steel	22117	20022 - 20024
	VX - FC 60 - Activated carbon filter	22314	20021 - 20023
	VX - FC 90 - Activated carbon filter	22322	20022 - 20024
	VX - FA 90 - Paper filter Vortex 90	22307	20022 - 20024
	G - 23/9" - Air replacement grilles	22114	ALL PRODUCT





APPLICATIONS





ARIETT RANGE

Centrifugal duct fans **LONG LIFE 30.000 h**

Centrifugal duct fans for wall or ceiling installation, particularly suitable thanks to their small size for the ventilation of windowless bathrooms and, more generally, of small or medium-size residential and commercial premises whose layout requires ducting of the exhaust.

Key features

- Reduced size, suitable for installation in small spaces.
- Reduced exhaust sleeve depth, compatible with installation immediately upstream of a 90° bend.
- High protection from water, suitable for use in Zone 1 bathroom installations and in the presence of high relative humidity.
- Sealed non-return valve to prevent unwanted inflows of air and bad odours when the device is switched off.

Design: F. Trabucco - M. Vecchi



Version

4 models, also available in versions with timer, with humidity sensor and presence sensor.

Technical features

- White, shock-proof, plastic resin (ABS) casings prevent ageing caused by exposure to sunlight ("UV resistant").
- Shaded pole motors, heat protected, with shafts mounted on ball bearings to guarantee long lasting (at least 30,000 h) continuous service at the maximum plate temperature. Speed adjustment using Vortice accessory devices.
- Forward-curved centrifugal impeller moulded in plastic resin, resistant to aggressive agents.
- Non-return valves to prevent unwanted inflows of air and bad odours when the device is switched off
- T model equipped with electronic timer for automatic product switch-off after a pre-fixed period of time, which can be set in the installation phase, from 3'-20' (default setting 3').
- T-HCS model equipped with circuit board with relative humidity sensor (RH), adjustable to 4 predefined threshold levels (60%, 70%, 80%, 90 %), alternatively can be set during installation, which determines automatic fan activation. The board integrates an electronic timer for automatic shut-down of the product after return to a RH below the pre-set threshold. The duration of the timer can be set at installation within the interval 3'-20' (default setting 3').
- PIR model equipped with an IR presence sensor which determines automatic fan activation in the presence of occupants in the serviced room. The board integrates an electronic timer for automatic shut-down of the product after the occupants have left the premises. The duration of the timer can be set at installation within the interval 3'-20' (default setting 3').
- Performance and safety certified by third party body (IMQ)
- Protection rating from dust and water: IPX4.
- Class of electric isolation: II □ (earthing not required).

TECHNICAL DATA

MODELS	CODE		V~50HZ	W max	A max	RPM max	MAX AIRFLOW		MAX PRESSURE		Lp dB(A)* 3m max	MAX °C	KG
	BASIC	TIMER					m³/h	l/s	mmH₂O	Pa			
ARIETT LL	11313	-	230	18	0.14	2315	70	19.4	12	118	40	40	1.50
ARIETT LL T	-	11966	230	18	0.14	2315	70	19.4	12	118	40	40	1.50

* Conforms with ISO 3744 for noise and pressure levels.



ARIETT RANGE | TECHNICAL DATA FOR REGULATION N° 1254/2014/UE

	UNIT OF MEASURE	ARIETT
Supplier's name or trade mark	-	Vortice
Specific Energy Consumption class SEC in average climate zone	-	NA
Specific Energy Consumption class SEC average	-	-5.5
Specific Energy Consumption class SEC cold	kWh/m ² year	-18.9
Specific Energy Consumption class SEC warm	-	2.1
Declared typology	-	RVU-U*
Type of drive	-	NA
Type of heat recovery system HRS	-	none
Thermal efficiency of heat recovery at reference air flow	%	NA
Maximum flow rate	m ³ /h	71
Electric power input of the fan drive, including any motor control equipment, at maximum flow rate	W	13.7
Sound power level LWA	LWA [DB(A)]	61
Reference flow rate	m ³ /s	0.0138
Reference pressure difference	Pa	77
SPI	W/(m ³ /h)	0.24547
Control factor CTRL	-	1
Control typology	-	manual
Maximum internal leakage rates	%	NA
Maximum external leakage rates	%	NA
Mixing rate	-	NA
Position and description of visual filter warning	-	NA
Airflow sensitivity to pressure variations at + 20 Pa and - 20 Pa	-	NA
Indoor/outdoor air tightness	m ³ /h	NA
Annual electricity consumption (AEC)	kWh electricity/year	338
AHS average Annual heating saved	-	1397
AHS cold Annual heating saved	kWh primary energy/year	2732
AHS warm Annual heating saved	-	632

* RVU-U: Unit Ventilation Residential - Unidirectional

** NRVU-U: Unit Ventilation Non Residential - Unidirectional

*** MSD: Multi-Speed Drive

NA: Not applicable

DIMENSIONS

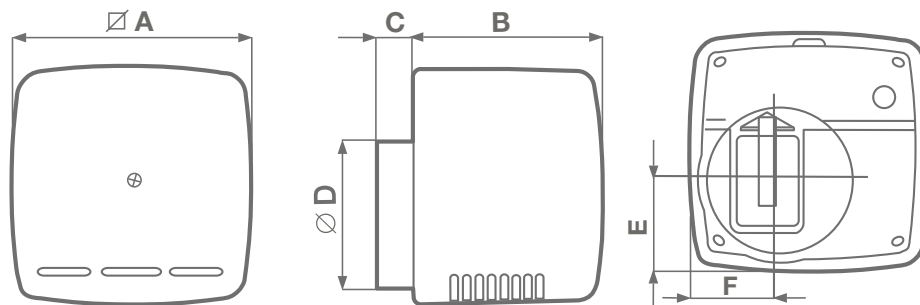

MODELS	∅ A	B	C	∅ D	E	F
ARIETT LL	156	123	25	97	60	60

Dimensions (mm)





RESIDENTIAL VENTILATION

ARIETT RANGE

PERFORMANCE CURVES



CONTROLLER

MODELS	DESCRIPTION	CODE	PRODUCT
	C 1.5 - Electronic speed controller 1.5 A	12966	ALL PRODUCTS
	SCNRB - Electronic speed controller built-in	12971	ALL PRODUCTS
	SCB KIT - Built-in controller adaptor for C 1.5	22481	12966

ACCESSORIES ON REQUEST

MODELS	DESCRIPTION	CODE	PRODUCT
	AIR DEFLECTOR	100/4 22310	ALL PRODUCTS



APPLICATIONS





ARIETT HABITAT RANGE

Centrifugal duct fans **LONG LIFE 30.000 h**

Centrifugal fans for wall or ceiling installation, particularly suitable thanks to their small size and special combination of performance and consumption for the continuous ventilation of small or medium-size residential and commercial premises whose layout requires ducting of the exhaust.

Key features

- Reduced size, suitable for installation in small spaces.
- Reduced exhaust sleeve depth, compatible with installation immediately upstream of a 90° bend.
- 2-speed fan motor, optimised for the continuous 24/7 ventilation of serviced rooms
- High protection from water, suitable for use in Zone 1 bathroom installations and in the presence of high relative humidity.

Design: F. Trabucco & Associates



Version

2 models.

Technical features

- White, shock-proof, plastic resin (ABS) casing prevents ageing caused by exposure to sunlight ("UV resistant").
- 2-speed heat protected shaded pole motor, with shaft mounted on ball bearings to guarantee long lasting (at least 30,000 h) continuous service at the maximum plate temperature. Speed adjustment using Vortice accessory devices.
- Forward-curved centrifugal impeller moulded in plastic resin, resistant to aggressive agents.
- Performance and safety certified by third party body (IMQ)
- Protection rating from dust and water: IPX4.
- Class of electric isolation: II □ (earthing not required).

TECHNICAL DATA

MODEL	CODE	V~50HZ	W min/max	A min/max	RPM min/max	MAX AIRFLOW		MAX PRESSURE		Lp dB(A) 3m max	MAX °C	KG
						m³/h min/max	l/s min/max	mmH₂O min/max	Pa min/max			
ARIETT HABITAT LL 15/30	12000	230-240	5 8	0.02 0.04	1260 1870	20 43	5.6 11.9	8 10	78 98	30 41.5	40	1.20
ARIETT HABITAT LL 20/75	12001	230-240	6 25	0.03 0.17	890 2470	27 85	7.5 23.6	8 12	78 118	30.5 51	40	1.40

* Conforms with ISO 3744 for noise and pressure levels.



ARIETT HABITAT RANGE | TECHNICAL DATA FOR REGULATION N° 1254/2014/UE

	UNIT OF MEASURE	ARIETT HABITATT LL 15/30	ARIETT HABITATT LL 20/75
Supplier's name or trade mark	-	Vortice	Vortice
Specific Energy Consumption class SEC in average climate zone	-	NA	NA
Specific Energy Consumption class SEC average	-	-4,2	0,2
Specific Energy Consumption class SEC cold	kWh/m ² year	-17,6	-13,2
Specific Energy Consumption class SEC warm	-	3,5	7,8
Declared typology	-	RVU-U*	RVU-U*
Type of drive	-	NA	NA
Type of heat recovery system HRS	-	none	none
Thermal efficiency of heat recovery at reference air flow	%	NA	NA
Maximum flow rate	m ³ /h	39	74
Electric power input of the fan drive, including any motor control equipment, at maximum flow rate	W	8,2	22,8
Sound power level LWA	LWA [DB(A)]	53	62
Reference flow rate	m ³ /s	0,0076	0,41120
Reference pressure difference	Pa	60	73
SPI	W/(m ³ /h)	0,28353	0,41120
Control factor CTRL	-	1	1
Control typology	-	manual	manual
Maximum internal leakage rates	%	NA	NA
Maximum external leakage rates	%	NA	NA
Mixing rate	-	NA	NA
Position and description of visual filter warning	-	NA	NA
Airflow sensitivity to pressure variations at + 20 Pa and - 20 Pa	-	NA	NA
Indoor/outdoor air tightness	m ³ /h	NA	NA
Annual electricity consumption (AEC)	kWh electricity/year	NA	NA
AHS average Annual heating saved	-	NA	NA
AHS cold Annual heating saved	kWh primary energy/year	NA	NA
AHS warm Annual heating saved	-	391	567

* RVU-U: Unit Ventilation Residential - Unidirectional

** NRVU-U: Unit Ventilation Non Residential - Unidirectional

*** MSD: Multi-Speed Drive

NA: Not applicable

DIMENSIONS

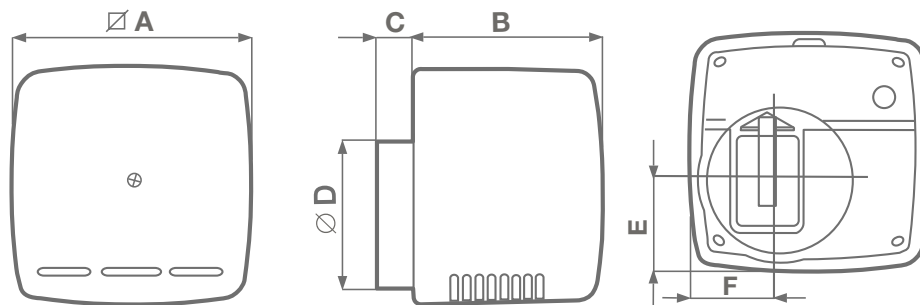

MODELS	∅ A	B	C	∅ D	E	F
ARIETT HABITAT LL	156	123	25	97	60	60

Dimensions (mm)





RESIDENTIAL VENTILATION

ARIETT HABITAT RANGE

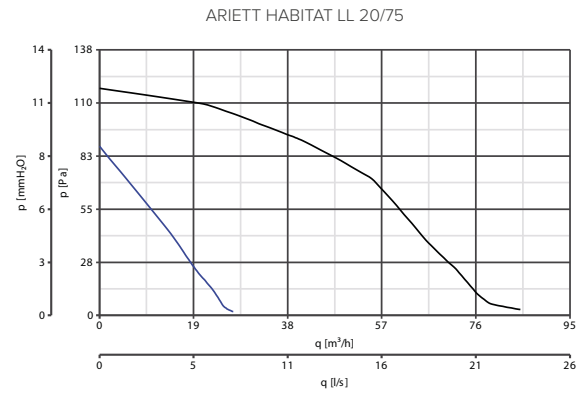
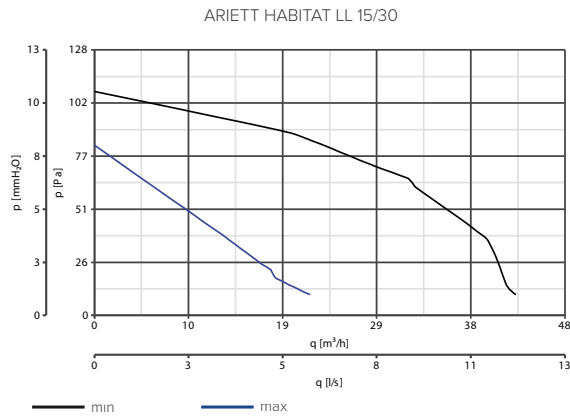
PERFORMANCE CURVES



CONTROLLER

MODELS	DESCRIPTION	CODE	PRODUCT
	C 1.5 - Electronic speed controller 1.5 A	12966	ALL PRODUCTS
	SCNRB - Electronic speed controller built-in	12971	ALL PRODUCTS
	SCB KIT - Built-in controller adaptor for C 1.5	22481	12966

ACCESSORIES ON REQUEST

MODELS	DESCRIPTION	CODE	PRODUCT
	AIR DEFLECTOR	100/4 22310	ALL PRODUCTS



APPLICATIONS





ARIETT I RANGE

Centrifugal duct fans for flush mounting **LONG LIFE 30.000 h**

Centrifugal duct fans for recessed installation in correspondence with walls and ceilings, particularly suitable for the ventilation of windowless bathrooms and, more generally, of small or medium-size residential and commercial premises whose layout requires ducting of the exhaust.

Key features

- Ultra-flat grille that minimises the aesthetic impact of the product
- With the use of appropriate optional accessories, possible installation in high false ceilings.
- Possibility of rear or side exhaust for increased installation flexibility
- High protection from water, suitable for use in Zone 1 bathroom installations and in the presence of high relative humidity.
- Sealed non-return valve to prevent unwanted inflows of air and bad odours when the device is switched off.

Design: F. Trabucco & Associates



Version

2 models, also available in version with timer.

Technical features

- White, shock-proof, plastic resin (ABS) casings and front grilles, resistant to ageing caused by exposure to sunlight ("UV resistant").
- Recessed boxes with rear exhaust, pre-set for vertical exhaust thanks to special nozzles provided as standard or for vertical exhaust using an optional flow diverter.
- Shaded pole motors, heat protected, with shafts mounted on ball bearings to guarantee long lasting (at least 30,000 h) continuous service at the maximum plate temperature. Speed adjustment using Vortice accessory devices.
- Forward-curved centrifugal impeller moulded in plastic resin, resistant to aggressive agents.
- Non-return valves to prevent unwanted inflows of air and bad odours when the device is switched off
- T model equipped with electronic timer for automatic product switch-off after a pre-fixed period of time, which can be set in the installation phase, from 3'-20' (default setting 3').
- Performance and safety certified by third party body (IMQ)
- Protection rating from dust and water: IPX4.
- Class of electric isolation: II □ (earthing not required).

TECHNICAL DATA

MODELS	CODE		V~50HZ	W max	A max	RPM max	MAX AIRFLOW		MAX PRESSURE		Lp dB(A)* 3m max	MAX °C	KG
	BASIC	TIMER					m³/h	l/s	mmH₂O	Pa			
ARIETT LL I	12010	-	230	19	0.13	2360 ¹ 2460 ²	80 ¹ 70 ²	22.2 ¹ 19.4 ²	11	108	40	40	1.90
ARIETT LL I T	-	12011	230	19	0.13	2360 ¹ 2460 ²	80 ¹ 70 ²	22.2 ¹ 19.4 ²	11	108	40	40	1.90

¹Rear air outlet. ²Side air outlet with high profile.



ARIETT I RANGE | TECHNICAL DATA FOR REGULATION N° 1254/2014/UE

	UNIT OF MEASURE	ARIETT LL I - ARIETT LL I T
Supplier's name or trade mark	-	Vortice
Specific Energy Consumption class SEC in average climate zone	-	NA
Specific Energy Consumption class SEC average	-	-5.3
Specific Energy Consumption class SEC cold	kWh/m ² year	-18.6
Specific Energy Consumption class SEC warm	-	-2,4
Declared typology	-	RVU-U*
Type of drive	-	NA
Type of heat recovery system HRS	-	none
Thermal efficiency of heat recovery at reference air flow	%	NA
Maximum flow rate	m ³ /h	72
Electric power input of the fan drive, including any motor control equipment, at maximum flow rate	W	13.75
Sound power level LWA	LWA [DB(A)]	64
Reference flow rate	m ³ /s	0.0140
Reference pressure difference	Pa	72
SPI	W/(m ³ /h)	0.25198
Control factor CTRL	-	1
Control typology	-	manual
Maximum internal leakage rates	%	NA
Maximum external leakage rates	%	NA
Mixing rate	-	NA
Position and description of visual filter warning	-	NA
Airflow sensitivity to pressure variations at + 20 Pa and - 20 Pa	-	NA
Indoor/outdoor air tightness	m ³ /h	NA
Annual electricity consumption (AEC)	kWh electricity/year	347
AHS average Annual heating saved	-	1397
AHS cold Annual heating saved	kWh primary energy/year	2732
AHS warm Annual heating saved	-	632

* RVU-U: Unit Ventilation Residential - Unidirectional

** NRUV-U: Unit Ventilation Non Residential - Unidirectional

*** MSD: Multi-Speed Drive

NA: Not applicable

DIMENSIONS

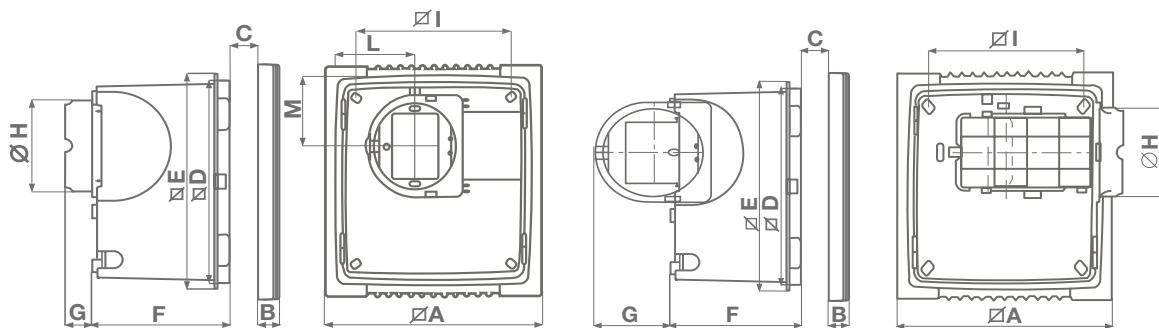

MODELS	∅A	B	C	∅D	∅E	F	G	H	∅I	L	M
ARIETT LL I	252	23	65	214,5	228	135,5	31,5 76,7	96,5	180	92	76

Dimensions (mm)



RESIDENTIAL VENTILATION

ARIETT I RANGE

MAIN COMPONENTS

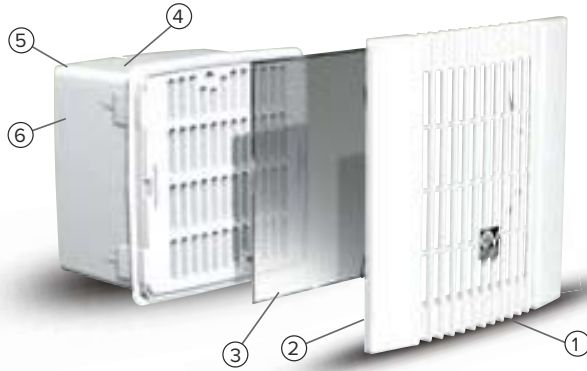



- ① Unobtrusive front grille.
- ② Support springs for the front grille, suitable for 65 mm max false ceilings.
- ③ Metallic filter which can be removed and washed (dishwasher safe) (available on LL version models only).
- ④ Made of rigid synthetic resin to guarantee high durability.
- ⑤ 100 mm dia. Outlet spigot which can be positioned to the rear or side (using optional accessories).
- ⑥ Backdraught-shutter to avoid back-flow when unit is turned off.

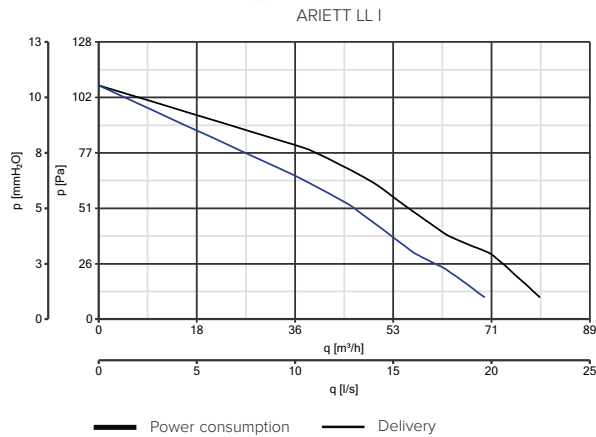

PERFORMANCE CURVES



CONTROLLER

MODELS	DESCRIPTION	CODE	PRODUCT
	C 1.5 - Electronic speed controller 1.5 A	12966	12010
	SCNRB - Electronic speed controller built-in	12971	ALL PRODUCTS
	SCB KIT - Built-in controller adaptor for C 1.5	22481	12966

ACCESSORIES ON REQUEST

MODELS	DESCRIPTION	CODE	PRODUCT	
	AIR DEFLECTOR	100/4	22310	ALL PRODUCTS
	HORIZONTAL OUTLET - HIGH PROFILE		22841	ALL PRODUCTS
	FALSE-CEILING/WALL INSTALLATION KIT		22823	ALL PRODUCTS



APPLICATIONS





VORT PRESS RANGE

Centrifugal duct fans **LONG LIFE 30.000 h**



2 or 3 speed centrifugal fans for wall or ceiling installation, designed for the ventilation of small or medium-size residential and commercial premises whose layout requires ducting of the exhaust.

Key features

- Silent operation.
- Reduced exhaust sleeve depth, compatible with installation immediately upstream of a 90° bend.
- 2 or 3 speed motors for the best balance between performance, consumption and sound emissions.
- Metal filters, easily removable to facilitate maintenance, dishwasher-safe
- Sealed non-return valves to prevent unwanted inflows of cold air and bad odours when the device is switched off.
- High protection from water, suitable for use in Zone 1 bathroom installations and in the presence of high relative humidity.

Design: F. Trabucco - M. Vecchi



Version

4 models, different in size, performance and supply, also available in version with timer.

Technical features

- White, shock-proof, plastic resin casings prevent ageing caused by exposure to sunlight ("UV resistant"). Fan motor housings mounted on antivibration supports inside the scroll, with sound-absorbing characteristics, ensuring especially quiet operation.
- 2 or 3 speed motors with thermal overload cut-out and shaft turning in ball bearings to guarantee long lasting continuous service (at least 30,000 h) at the maximum plate temperature. Speed adjustment using Vortice accessory devices.
- Forward-curved centrifugal impellers moulded in plastic resin, resistant to aggressive agents.
- Multi-layer aluminium mesh filters, dishwasher-safe.
- Non-return valves with very high sealing silicone membrane to prevent unwanted inflows of air and bad odours when the device is switched off.
- T models equipped with an "intelligent" electronic timer: if the light is on in the serviced room, the fan starts up at maximum speed after about 40". If the light is switched off, the device instantly switches to minimum speed, switching off automatically after an amount of time that can be set during installation from 3' to 20' (default setting 3').
- Performance and safety certified by third party body (IMQ)
- Class of electric isolation: II □ (earthing not required).





TECHNICAL DATA

MODELS	CODE		V~50HZ	W max	A max	RPM max	MAX AIRFLOW		MAX PRESSURE		Lp dB(A)* 3m max	MAX °C	KG
	BASIC	TIMER					m³/h	l/s	mmH ₂ O	Pa			
VORT PRESS 110 LL	11967	11968	220-240	12 24	0,07 0,22	925 1760	55 110	15,3 30,6	10 16	98 157	30 41	40	1,95
VORT PRESS 220 LL	11977	11978	220-240	14 64	0,11 0,42	1200 2380	125 260	35 72	11 35	108 343	43 55	40	2,30

* Conforms with ISO 3744 for noise and pressure levels.

VORT PRESS RANGE | TECHNICAL DATA FOR REGULATION N° 1254/2014/UE

	UNIT OF MEASURE	VORT PRESS 110 LL - VORTICE PRESS 110 LL T
Supplier's name or trade mark	-	Vortice
Specific Energy Consumption class SEC in average climate zone	-	NA
Specific Energy Consumption class SEC average	-	-2,7
Specific Energy Consumption class SEC cold	kWh/m ² year	-16
Specific Energy Consumption class SEC warm	-	5,0
Declared typology	-	RVU-U*
Type of drive	-	NA
Type of heat recovery system HRS	-	none
Thermal efficiency of heat recovery at reference air flow	%	NA
Maximum flow rate	m ³ /h	109
Electric power input of the fan drive, including any motor control equipment, at maximum flow rate	W	29,0
Sound power level LWA	LWA [DB(A)]	62
Reference flow rate	m ³ /s	0.0212
Reference pressure difference	Pa	95
SPI	W/(m ³ /h)	0.32765
Control factor CTRL	-	1
Control typology	-	manual
Maximum internal leakage rates	%	NA
Maximum external leakage rates	%	NA
Mixing rate	-	NA
Position and description of visual filter warning	-	NA
Airflow sensitivity to pressure variations at + 20 Pa and – 20 Pa	-	NA
Indoor/outdoor air tightness	m ³ /h	NA
Annual electricity consumption (AEC)	kWh electricity/year	451
AHS average Annual heating saved	-	1397
AHS cold Annual heating saved	kWh primary energy/year	2732
AHS warm Annual heating saved	-	632

* RVU-U: Unit Ventilation Residential - Unidirectional

** NRVU-U: Unit Ventilation Non Residential - Unidirectional

*** MSD: Multi-Speed Drive

NA: Not applicable



RESIDENTIAL VENTILATION

VORT PRESS RANGE

VORT PRESS RANGE | TECHNICAL DATA FOR REGULATION N° 1254/2014/UE

	UNIT OF MEASURE	VORT PRESS 220 LL - VORTICE PRESS 220 LL T
Supplier's name or trade mark	-	Vortice
Declared typology	-	NRVU-U*
Type of drive	-	VSD***
Type of heat recovery system HRS	-	None
Thermal efficiency of heat recovery	-	NA
Nominal NRVU flow rate	m ³ /s	0,0586
Effective electric power input	kW	0,06
SFPint	W/(m ³ /h)	606,75
Face velocity at design flow rate	m/s	7,93134
Nominal external pressure ($\Delta p_{s,int}$)	Pa	110
Internal pressure drop of ventilation components ($\Delta p_{s,int}$)	Pa	160
Internal pressure drop of non-ventilation components ($\Delta p_{s,int}$)	Pa	0
Static efficiency of fans used in accordance with Regulation (EU) N. 3272011	%	26,4
Declared maximum internal leakage rate of the casing of ventilation units	%	NA
Declared maximum external leakage rate of the casing of ventilation units	%	NA
Energy performance energy or classification of the filters	-	NA
Description of visual filter warning	%	NA
Casing sound power level (LWA)	dB(A)	76

* RVU-U: Unit Ventilation Residential - Unidirectional

** NRVU-U: Unit Ventilation Non Residential - Unidirectional

*** VSD: Variable-Speed Drive

NA: Not applicable

DIMENSIONS

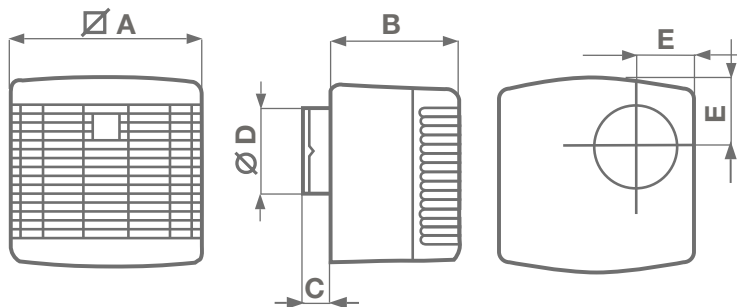

MODELS	$\varnothing A$	B	C	$\varnothing D$	E
VORT PRESS 110 LL	202	147	30	97	60

Dimensions (mm)

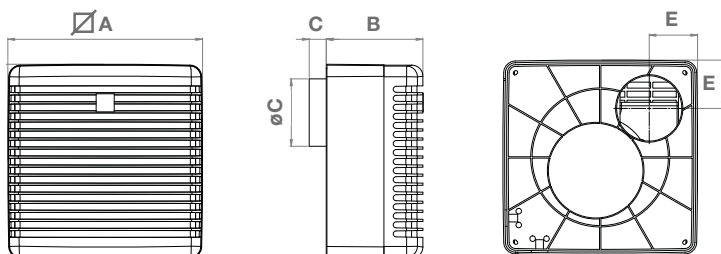

MODELS	$\varnothing A$	B	C	$\varnothing D$	E
VORT PRESS 220 LL	280	140	28	97	70

Dimensions (mm)



MAIN COMPONENTS

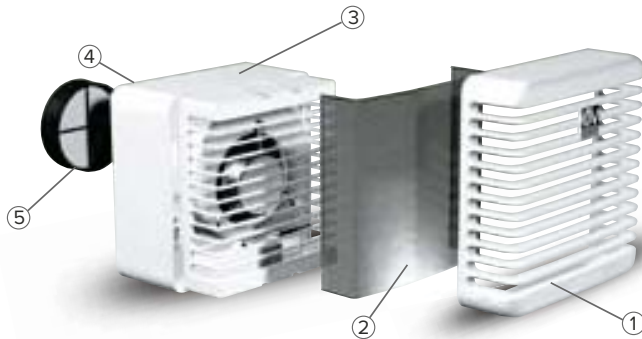

- ① Front grille.
- ② Metallic filter which can be removed and washed (dishwasher safe).
- ③ Made of rigid synthetic resin to guarantee high durability.
- ④ 100 mm dia. outlet spigot.
- ⑤ Silicon backdraught shutter to avoid back-flow when the unit is turned off.

PERFORMANCE CURVES

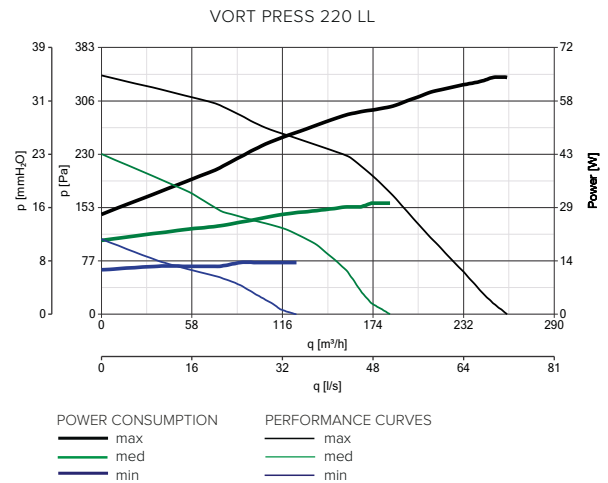
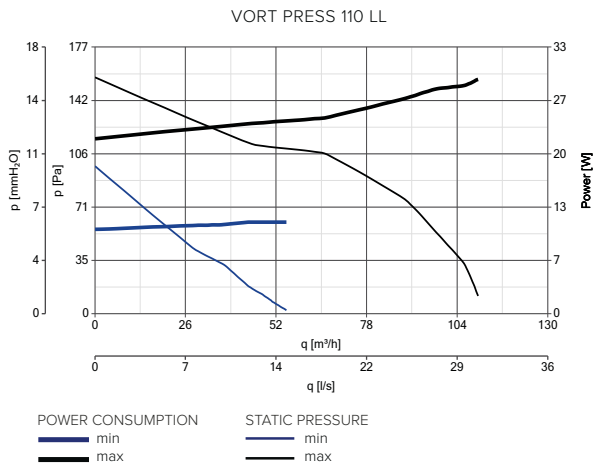

CONTROLLER

MODELS	DESCRIPTION	CODE	PRODUCT
	C 1.5 - Electronic speed controller 1.5 A	12966	ALL PRODUCTS
	SCNRB - Electronic speed controller built-in	12971	ALL PRODUCTS
	SCB KIT - Built-in controller adaptor for C 1.5	22481	12966
	POT-IT - Potentiometer equipped with On/Off switch, for installation in 503 Standard Box.	12826	11977 - 11978
	POT - Potentiometer for installation in Standard DIN box.	12828	11977 - 11978

ACCESSORIES ON REQUEST

MODELS	DESCRIPTION	CODE	PRODUCT
	AIR DEFLECTOR	100/4 22310	ALL PRODUCTS



VORT PRESS HABITAT RANGE

Centrifugal duct fans **LONG LIFE 30.000 h**

Design: F. Trabucco & Associati



2 speed centrifugal fans for wall or ceiling installation, particularly suitable thanks to their small size and special combination of performance and consumption for the continuous ventilation of medium or large-size residential and commercial premises whose layout requires ducting of the exhaust.

Key features

- Reduced exhaust sleeve depth, compatible with installation immediately upstream of a 90° bend.
- 2-speed fan motor, optimised for the continuous 24/7 ventilation of serviced rooms
- High protection from water, suitable for use in Zone 1 bathroom installations and in the presence of high relative humidity.
- Dishwasher safe metallic filters.

Version

2 models.

Technical features

- White, shock-proof, plastic resin casing prevents ageing caused by exposure to sunlight ("UV resistant"). Fan motor housing mounted on antivibration supports inside a scroll, with sound-absorbing characteristics, ensuring especially quiet operation.
- Heat-protected 2-speed motor with shaft mounted on ball bearings to guarantee long lasting continuous service (at least 30,000 h) at the maximum plate temperature. Speed adjustment using Vortice accessory devices.
- Forward-curved centrifugal impeller moulded in plastic resin, resistant to aggressive agents.
- Multi-layer aluminium mesh filter, dishwasher-safe.
- Performance and safety certified by third party body (IMQ)
- Class of electric isolation: II □ (earthing not required).

TECHNICAL DATA

MODELS	CODE	V~50HZ	W		RPM	MAX AIRFLOW		MAX PRESSURE		Lp dB(A) 3m max	MAX °C	KG
			min/max	A min/max		m³/h min/max	l/s min/max	mmH ₂ O min/max	Pa min/max			
VORT PRESS HABITAT LL 30/90	12002	230	8 22	0.06 0.18	820 1450	51 101	14.2 28.1	4 14	39 137	28.5 44.5	40	2.1
VORT PRESS HABITAT LL 45/135	12004	230	4 29	0.04 0.12	430 1170	52 149	14.4 41.4	5 23	49 225	26.5 48	40	2.7

* Conforms with ISO 3744 for noise and pressure levels.



VORT PRESS HABITAT RANGE | TECHNICAL DATA FOR REGULATION N° 1254/2014/UE

	UNIT OF MEASURE	ARIETT HABITATT LL 15/30	ARIETT HABITATT LL 20/75
Supplier's name or trade mark	-	Vortice	Vortice
Specific Energy Consumption class SEC in average climate zone	-	NA	NA
Specific Energy Consumption class SEC average	-	-2,6	-4,0
Specific Energy Consumption class SEC cold	kWh/m ² year	-15,9	-17,3
Specific Energy Consumption class SEC warm	-	5,1	3,7
Declared typology	-	RVU-U*	RVU-U*
Type of drive	-	NA	NA
Type of heat recovery system HRS	-	none	none
Thermal efficiency of heat recovery at reference air flow	%	NA*	NA*
Maximum flow rate	m ³ /h	90	143
Electric power input of the fan drive, including any motor control equipment, at maximum flow rate	W	21,0	29,58
Sound power level LWA	LWA [DB(A)]	56	59
Reference flow rate	m ³ /s	0,0175	0,0278
Reference pressure difference	Pa	53	95
SPI	W/(m ³ /h)	0,33016	0,28971
Control factor CTRL	-	1	1
Control typology	-	manual	manual
Maximum internal leakage rates	%	NA	NA
Maximum external leakage rates	%	NA	NA
Mixing rate	-	NA	NA
Position and description of visual filter warning	-	NA	NA
Airflow sensitivity to pressure variations at + 20 Pa and - 20 Pa	-	NA	NA
Indoor/outdoor air tightness	m ³ /h	NA	NA
Annual electricity consumption (AEC)	kWh electricity/year	455	339
AHS average Annual heating saved	-	1397	1397
AHS cold Annual heating saved	kWh primary energy/year	2732	2732
AHS warm Annual heating saved	-	632	632

* RVU-U: Unit Ventilation Residential - Unidirectional

** NRUVU-U: Unit Ventilation Non Residential - Unidirectional

*** MSD: Multi-Speed Drive

NA: Not applicable

DIMENSIONS

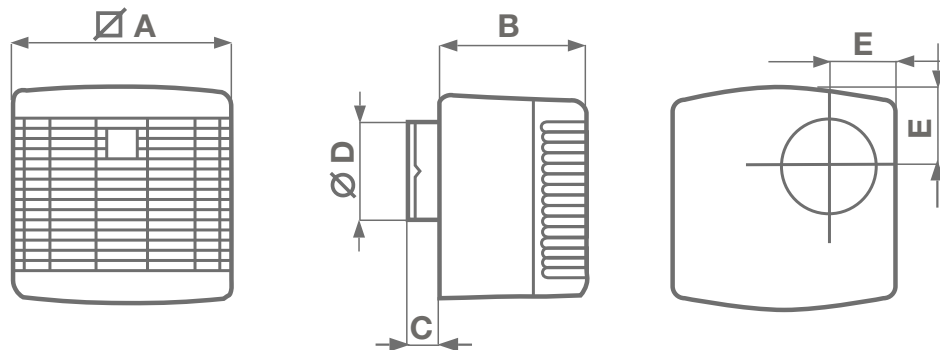

MODEL	Ø A	B	C	Ø D	E
VORT PRESS HABITAT LL 30/90	202	147	30	97	73
VORT PRESS HABITAT LL 45/135	275	140	28	97	73

Dimensions (mm)



RESIDENTIAL VENTILATION

VORT PRESS HABITAT RANGE

MAIN COMPONENTS

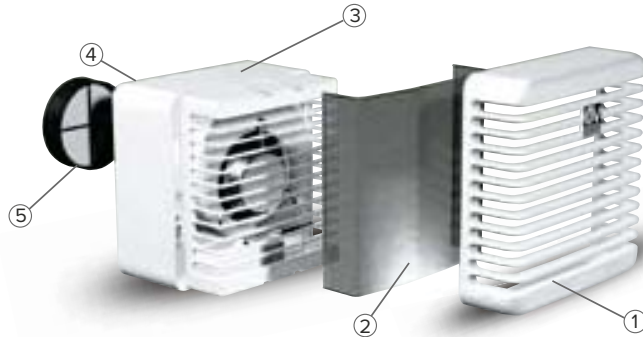

- ① Front grille.
- ② Metallic filter which can be removed and washed (dishwasher safe).
- ③ Made of rigid synthetic resin to guarantee high durability.
- ④ 100 mm dia. outlet spigot.
- ⑤ Silicon backdraught shutter to avoid back-flow when the unit is turned off.

PERFORMANCE CURVES

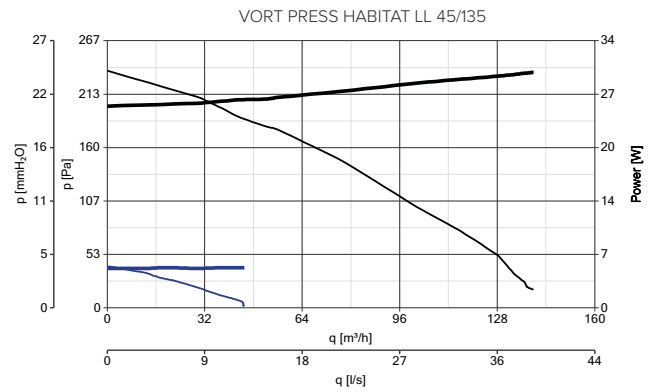
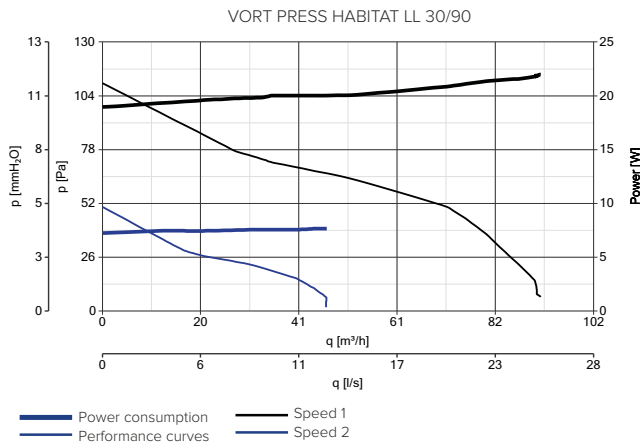

CONTROLLER

MODELS	DESCRIPTION	CODE	PRODUCT
	C 1.5 - Electronic speed controller 1.5 A	12966	ALL PRODUCTS
	SCNRB - Electronic speed controller built-in	12971	ALL PRODUCTS
	SCB KIT - Built-in controller adaptor for C 1.5	22481	12966

ACCESSORIES ON REQUEST

MODELS	DESCRIPTION	CODE	PRODUCT
	AIR DEFLECTOR	100/4 22310	ALL PRODUCTS



APPLICATIONS





VORT PRESS I RANGE

Centrifugal duct fans for flush mounting **LONG LIFE 30.000 h**

2 or 3 speed centrifugal fans for recessed installation in correspondence with walls or ceilings, particularly suitable for the ventilation of small or medium-size residential and commercial premises whose layout requires ducting of the exhaust.

Key features

- Silent operation.
- Ultra-flat grilles that minimise the aesthetic impact of the products
- 2-speed motors for the best balance between performance, consumption and sound emissions.
- Metal filters, easily removable to facilitate maintenance, dishwasher-safe
- Sealed non-return valves to prevent unwanted inflows of cold air and bad odours when the device is switched off.
- High protection from water, suitable for use in Zone 1 bathroom installations and in the presence of high relative humidity.

Version

2 models.

Technical features

- White, shock-proof, plastic resin casings and front grilles, resistant to ageing caused by exposure to sunlight ("UV resistant"). Fan motor housings mounted on antivibration supports inside the scroll, with sound-absorbing characteristics, ensuring especially quiet operation.
- Recessed boxes with rear exhaust.
- 2 or 3 speed motors with thermal overload cut-out and shaft turning in ball bearings to guarantee long lasting continuous service (at least 30,000 h) at the maximum plate temperature. Speed adjustment using Vortice accessory devices.
- Forward-curved centrifugal impellers moulded in plastic resin, resistant to aggressive agents.
- Multi-layer aluminium mesh filters, dishwasher-safe.
- Non-return valves with very high sealing silicone membrane to prevent unwanted inflows of air and bad odours when the device is switched off.
- T models equipped with an "intelligent" electronic timer: if the light is on in the serviced room, the fan starts up at maximum speed after about 40". If the light is switched off, the device instantly switches to minimum speed, switching off automatically after an amount of time that can be set during installation from 3' to 20' (default setting 3').
- Performance and safety certified by third party body (IMQ)
- Class of electric isolation: II \square (earthing not required).

Design: F. Trabucco & Associates (Vort Press I 110)
F. Trabucco - M. Vecchi (Vort Press I 140 /240)



TECHNICAL DATA

MODELS	CODE		V~50HZ	W max	A max	RPM max	MAX AIRFLOW		MAX PRESSURE		Lp dB(A)* 3m max	MAX °C	KG
	BASE	TIMER					m³/h	l/s	mmH ₂ O	Pa			
VORT PRESS 110 LL I	11995	11996	220	12	0,07	970 ¹	60 ¹	16,7 ¹	8,9 ¹	87 ¹	<30	40	2,1
			240	24	0,18	1720 ¹	120 ¹	33,3 ¹	14,5 ¹	142 ¹			
						1090 ²	50 ²	13,9 ²	8,3 ²	181 ²			
						1980 ²	100 ²	27,8 ²	13,5 ²	132 ²			
VORT PRESS 140 LL I	11971	11972	220	16	0,05	594 ¹	55 ¹	15,3 ¹	8 ¹	78 ¹	<30	40	2,9
			240	27	0,10	1130 ¹	118 ¹	32,8 ¹	22 ¹	216 ¹			
						450 ²	67 ²	18,6 ²	8 ²	78 ²			
						829 ²	140 ²	38,9 ²	22 ²	216 ²			

¹Rear air outlet. ²Side air outlet with high profile.



VORT PRESS I EP RANGE | TECHNICAL DATA FOR REGULATION N° 1254/2014/UE

	UNIT OF MEASURE	VORT PRESS 110 LL I	VORT PRESS 140 LL I
Supplier's name or trade mark	-	Vortice	Vortice
Specific Energy Consumption class SEC in average climate zone	-	NA	NA
Specific Energy Consumption class SEC average	-	-5,1	-5,8
Specific Energy Consumption class SEC cold	kWh/m ² year	-18,5	-19,2
Specific Energy Consumption class SEC warm	-	2,5	1,8
Declared typology	-	RVU-U*	RVU-U*
Type of drive	-	NA	NA
Type of heat recovery system HRS	-	none	none
Thermal efficiency of heat recovery at reference air flow	%	NA*	NA*
Maximum flow rate	m ³ /h	117	133
Electric power input of the fan drive, including any motor control equipment, at maximum flow rate	W	23,1	23,5
Sound power level LWA	LWA [DB(A)]	62	59
Reference flow rate	m ³ /s	0,0228	0,0259
Reference pressure difference	Pa	66	88
SPI	W/(m ³ /h)	0,25641	0,23631
Control factor CTRL	-	1	1
Control typology	-	manual	manual
Maximum internal leakage rates	%	NA	NA
Maximum external leakage rates	%	NA	NA
Mixing rate	-	NA	NA
Position and description of visual filter warning	-	NA	NA
Airflow sensitivity to pressure variations at + 20 Pa and – 20 Pa	-	NA	NA
Indoor/outdoor air tightness	m ³ /h	NA	NA
Annual electricity consumption (AEC)	kWh electricity/year	353	326
AHS average Annual heating saved	-	1397	1397
AHS cold Annual heating saved	kWh primary energy/year	2732	2732
AHS warm Annual heating saved	-	632	632

* RVU-U: Unit Ventilation Residential - Unidirectional ** NRVU-U: Unit Ventilation Non Residential - Unidirectional *** MSD: Multi-Speed Drive **** VSD: Variable-Speed Drive NA: Not applicable



RESIDENTIAL VENTILATION

VORT PRESS I RANGE

DIMENSIONS

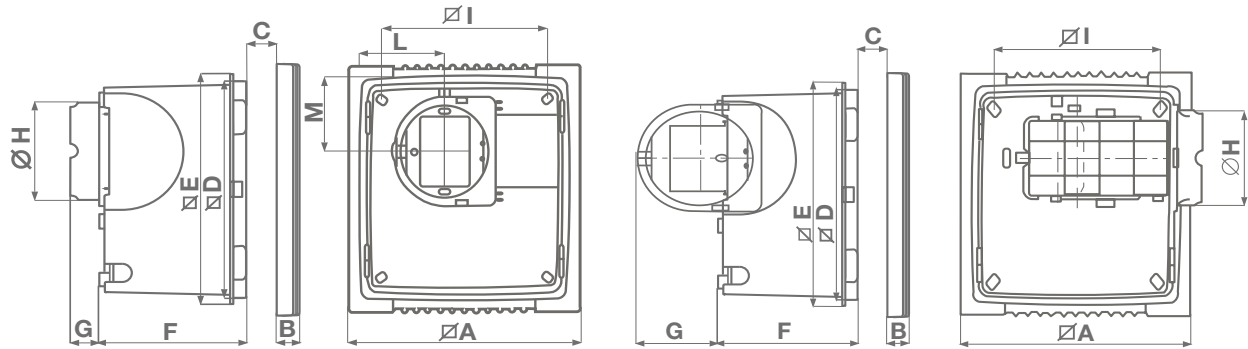

MODEL	∅A	B	C	∅D	∅E	F	G	H	∅I	L	M
VORT PRESS 110 LL I	252	23	65	214,5	228	135,5	31,5 76,7	96,5	180	92	76

Dimensions (mm)

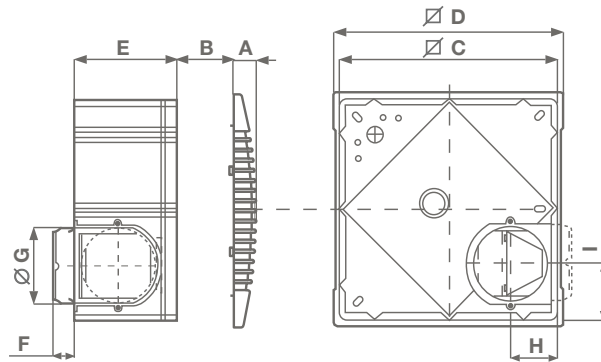

MODEL	A	∅B	∅C	∅D	E	F	G	H	∅I
VORT PRESS 140 LL I	28	65	284	300	133	28,5	97	62	71,5

Dimensions (mm)



PERFORMANCE CURVES

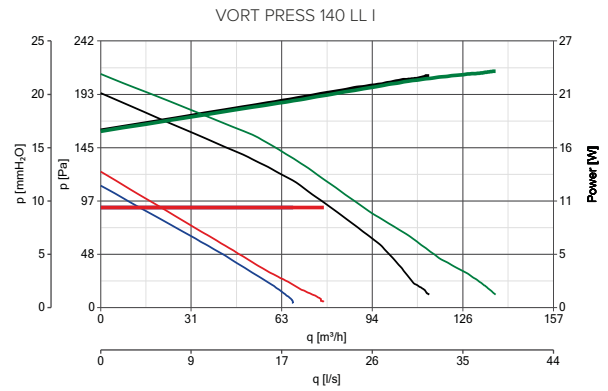
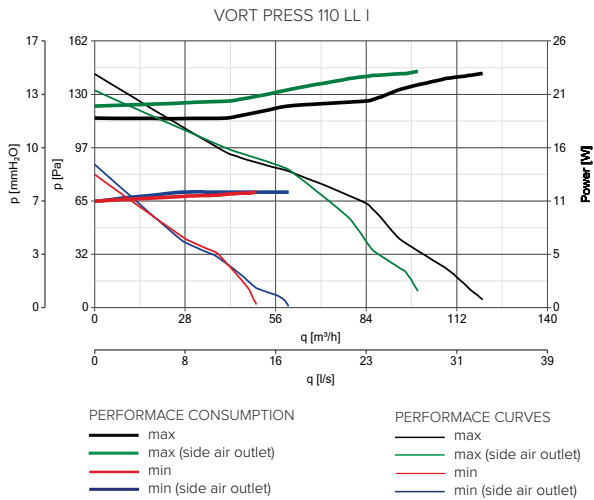

CONTROLLER

MODELS	DESCRIPTION	CODE	PRODUCT
	C 1.5 - Electronic speed controller 1.5 A	12966	12010
	SCNRB - Electronic speed controller built-in	12971	ALL PRODUCTS
	SCB KIT - Built-in controller adaptor for C 1.5	22481	12966
	POT-IT - Potentiometer equipped with On/Off switch, for installation in 503 Standard Box.	12826	11977 - 11978
	POT - Potentiometer for installation in Standard DIN box.	12828	11977 - 11978

ACCESSORIES ON REQUEST

MODELS	DESCRIPTION	CODE	PRODUCT	
	AIR DEFLECTOR	100/4	22310	ALL PRODUCTS
	HORIZONTAL OUTLET - HIGH PROFILE		22841	ALL PRODUCTS
	FALSE-CEILING/WALL INSTALLATION KIT		22823	ALL PRODUCTS
	VP-C - KIT FOR FALSE CEILING INSTALLATIONS (MAX HEIGHT 40 CM).		22815	11971 - 11972



Design: F. Trabucco & Associates



VORT QUADRO RANGE

Centrifugal duct fans

Centrifugal fans for wall or ceiling installation, designed for the ventilation of residential and commercial premises whose layout requires ducting of the exhaust. The elegant front panel which hides the hole behind it reduces the aesthetic impact of the installed product.

Key features

- Closed front panel that confers a modern image to the product and facilitates its cleaning.
- Reduced exhaust sleeve depth, compatible with installation immediately upstream of a 90° bend.
- Decentralised exhaust which, with the 360° adjustable front panel, amplifies the range of possible installations
- 2 or 3-speed motors for the best balance between performance, consumption and sound emissions.
- High protection from water, suitable for use in Zone 1 bathroom installations and in the presence of high relative humidity.

Version

6 models, different in size, performance and supply, also available in versions with timer and relative humidity sensor.

Technical features

- White, shock-proof, plastic resin (ABS) casings prevent ageing caused by exposure to sunlight ("UV resistant").
- 3-speed fan motors, obtained from the combination of:
 - Heat protected motors with shafts mounted on ball bearings to guarantee long lasting continuous service (at least 30,000 h) at the maximum plate temperature. Speed adjustment using Vortice accessory devices.
 - Forward-curved centrifugal impellers moulded in plastic resin, resistant to aggressive agents.
- 3-position speed selector, including ON/ OFF command, compatible with wall and recessed box installation as per standard UNI 503.
- Dishwasher-safe air filters in PU.
- Non-return valves integrated on the exhaust ducts to prevent unwanted inflows of air and bad odours when the appliance is switched off.
- T models equipped with electronic timer for automatic product switch-off after a pre-fixed period of time, which can be set in the installation phase, from 3'-20' (default setting 3').
- T-HCS models equipped with circuit board with relative humidity sensor (RH), adjustable to 4 predefined threshold levels (60%, 70%, 80%, 90 %), alternatively can be set during installation, which determines automatic fan activation. The board integrates an electronic timer for automatic shut-down of the product after return to a RH below the pre-set threshold. The duration of the timer can be set at installation within the interval 3'-20' (default setting 3').
- Performance and safety certified by third party body (IMQ)
- Class of electric isolation: II □ (earthing not required).



RANGE

	BASE	TIMER	TIMER HCS
MICRO 80	11638 MICRO 80	11648 MICRO 80 T	-
MICRO 100	11936 MICRO 100 11937 MICRO 100 ES	11940 MICRO 100 T 11941 MICRO 100 T ES	11945 MICRO 100 THCS
MEDIO	11944 MEDIO	11946 MEDIO T	11975 MEDIO THCS
SUPER	11952 SUPER	11954 SUPER T	11989 SUPER THCS



TECHNICAL DATA

MODELS	V~50HZ	W min/max	A min/max	RPM min/max	MAX AIRFLOW		MAX PRESSURE		Lp dB(A) 3m min/max	MAX °C	KG
					m ³ /h min/max	l/s min/max	mmH ₂ O min/max	Pa min/max			
MICRO 80	220-240	19 27	0.10 0.13	1150 1580	60 85	17 24	22 27	216 265	28.7 37.0	50	1.79
MICRO 100	220-240	20 28	0.10 0.13	1180 1600	65 90	18 25	16 22	157 216	32.3 39.2	50	1.80
MICRO 100 ES	220 - 240	8 15	0,08 0,12	1235 1630	65 90	18 25	9 18	88 177	34,5 37,4	50	1,80
MEDIO	220-240	25 29	0.14 0.18	1150 1890	70 120	19 33	22 34	216 329	36,7 43,4	50	2.50
SUPER	220-240	50 105	0.36 0.50	1400 2200	140 280	38 77	23 50	226 490	41.9 48.6	50	3.77



RESIDENTIAL VENTILATION

VORT QUADRO RANGE

VORT QUADRO RANGE | TECHNICAL DATA FOR REGULATION N° 1254/2014/UE

	UNIT OF MEASURE	MICRO 80	MICRO 100	MEDIO
Supplier's name or trade mark	-	Vortice	Vortice	Vortice
Specific Energy Consumption class SEC in average climate zone	-	NA	NA	NA
Specific Energy Consumption class SEC average	-	-0,5	0,0	0
Specific Energy Consumption class SEC cold	kWh/m ² year	-13,9	-13,3	-14
Specific Energy Consumption class SEC warm	-	7,2	7,7	7
Declared typology	-	RVU-U**	RVU-U**	RVU-U**
Type of drive	-	NA	NA	VSD****
Type of heat recovery system HRS	-	none	none	none
Thermal efficiency of heat recovery at reference air flow	%	NA	NA	NA
Maximum flow rate	m ³ /h	95	92	103
Electric power input of the fan drive, including any motor control equipment, at maximum flow rate	W	28,7	28,1	29,4
Sound power level LWA	LWA [DB(A)]	58	60	64
Reference flow rate	m ³ /s	0,0185	0,0179	0,0286
Reference pressure difference	Pa	148	196	141
SPI	W/(m ³ /h)	0,39098	0,40683	0,398
Control factor CTRL	-	1	1	1
Control typology	-	manual	manual	manual
Maximum internal leakage rates	%	NA	NA	NA
Maximum external leakage rates	%	NA	NA	NA
Mixing rate	-	NA	NA	NA
Position and description of visual filter warning	-	NA	NA	NA
Airflow sensitivity to pressure variations at + 20 Pa and - 20 Pa	-	NA	NA	0,10
Indoor/outdoor air tightness	m ³ /h	NA	NA	NA
Annual electricity consumption (AEC)	kWh electricity/year	539	561	549
AHS average Annual heating saved	-	1397	1397	1397
AHS cold Annual heating saved	kWh primary energy/year	2732	2732	2732
AHS warm Annual heating saved	-	632	632	632

* RVU-U: Unit Ventilation Residential - Unidirectional - **NRVU-U: Unit Ventilation Non Residential - Unidirectional - ***MSD: Multi-Speed Drive - ****VSD: Variable-Speed Drive - NA: Not applicable

VORT QUADRO RANGE | TECHNICAL DATA FOR REGULATION N° 1254/2014/UE

	UNIT OF MEASURE	SUPER
Supplier's name or trade mark	-	Vortice
Declared typology	-	NRVU-U**
Type of drive	-	VSD***
Type of heat recovery system HRS	-	None
Thermal efficiency of heat recovery	-	NA
Nominal NRVU flow rate	m ³ /s	0,05556
Effective electric power input	kW	0,090
SFPint	W/(m ³ /h)	NA
Face velocity at design flow rate	m/s	7,528
Nominal external pressure ($\Delta p_{s,int}$)	Pa	200
Internal pressure drop of ventilation components ($\Delta p_{s,int}$)	Pa	245
Internal pressure drop of non-ventilation components ($\Delta p_{s,int}$)	Pa	0
Static efficiency of fans used in accordance with Regulation (EU) N. 3272011	%	27,5
Declared maximum internal leakage rate of the casing of ventilation units	%	NA
Declared maximum external leakage rate of the casing of ventilation units	%	4,2
Energy performance energy or classification of the filters	-	NA
Description of visual filter warning	%	NA
Casing sound power level (LWA)	dB(A)	69

* RVU-U: Unit Ventilation Residential - Unidirectional - **NRVU-U: Unit Ventilation Non Residential - Unidirectional - ***VSD: Variable-Speed Drive



DIMENSIONS

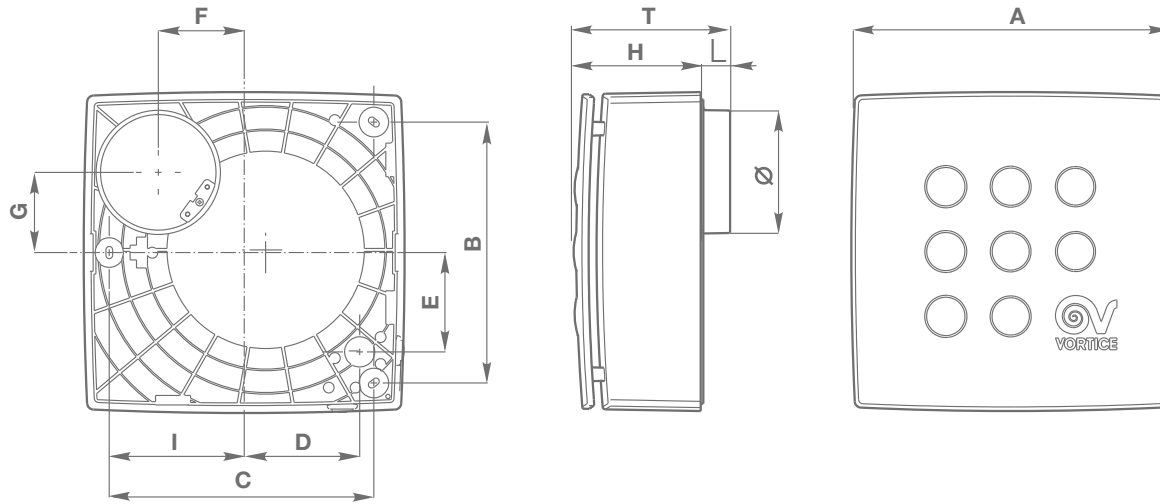

MODELS	∅A	B	C	D	E	F	G	H	I	L	T	∅
MICRO 80	239	195	197	85	74	64	60	97	100	20	117	73.5
MICRO 100	239	195	197	85	74	64	60	97	100	20	117	92.5/97

Dimensions (mm)

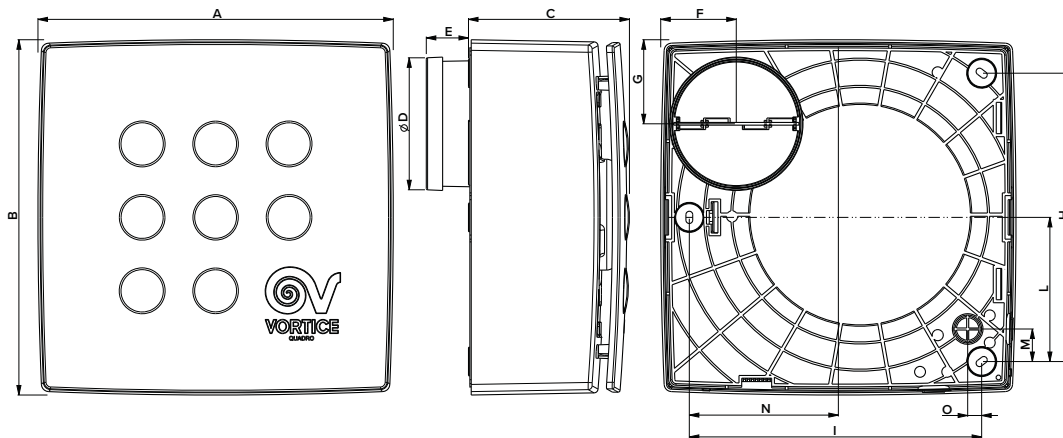

MODELS	∅A	B	C	D	E	F	G	H	I	L	M	N	O
MEDIO	261	261	119	97	31	55,5	62	212	215	106	24	110	10
SUPER	290	290	144	97	31	58	64	236	239	118	26	125	6,5

Dimensions (mm)



PERFORMANCE CURVES

MICRO 80

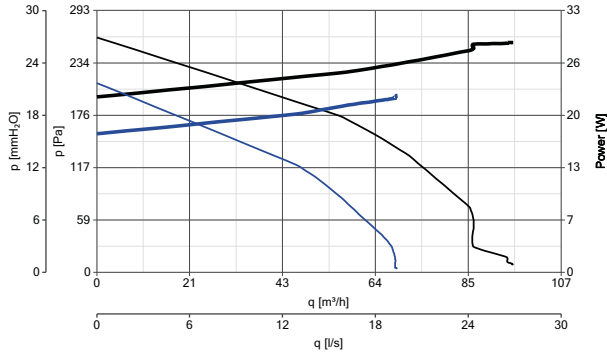

MICRO 100

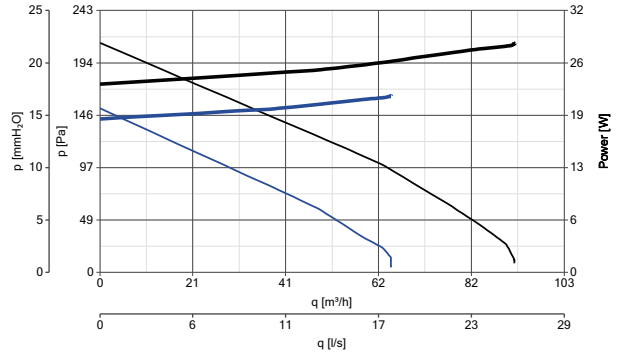

MICRO 100 ES

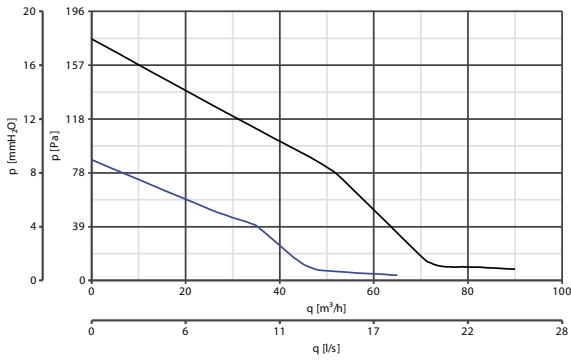

PERFORMANCE CURVES POWER CONSUMPTION
 — max — max
 — min — min

MEDIO

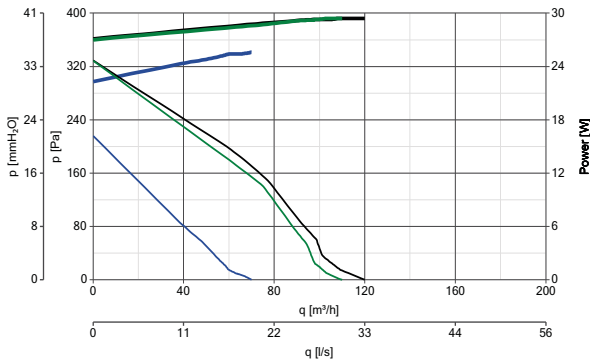

PERFORMANCE CURVES POWER CONSUMPTION
 — Speed 1 — Speed 1
 — Speed 2 — Speed 2
 — Speed 3 — Speed 3

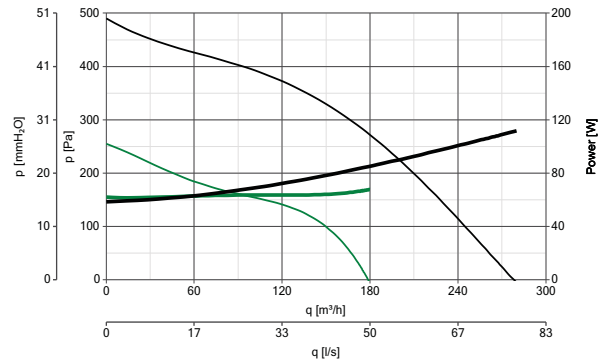

SUPER



PERFORMANCE CURVES POWER CONSUMPTION
 — min — min
 — max — max



CONTROLLER

MODELS	DESCRIPTION	CODE	PRODUCT
	C 1.5 - Electronic speed controller 1.5 A	12966	ALL PRODUCTS
	SCB KIT - Built-in controller adaptor for C 1.5	22481	12966
	TRIO-S - Built-in controller adaptor for C 1.5	12871	11952 - 11954 - 11989

ACCESSORIES ON REQUEST

MODELS	DESCRIPTION	CODE	PRODUCT
	AIR DEFLECTOR	100/4 22310	ALL PRODUCTS

APPLICATIONS





Design: F. Trabucco & Associates



VORT QUADRO I RANGE

Centrifugal duct fans for flush mounting

2-3 speed centrifugal duct fans for recessed installation in correspondence with walls and ceilings, designed for ventilation of residential and commercial premises whose layout requires ducting of the exhaust. The elegant front panel which hides the hole behind it reduces the aesthetic impact of the installed product. Standard supplied equipment includes a speed selector.

Key features

- Closed front panel that confers a modern image to the product and facilitates its cleaning.
- Possibility of rear or side ducting.
- Possibility of connection to a second duct for additional ventilation of an adjacent room.
- 2 or 3 speed fan motors for an ideal compromise between performance, consumption and sound emissions.
- High protection from water, suitable for use in Zone 1 bathroom installations and in the presence of high relative humidity.
- Non-return valves to prevent unwanted inflows of cold air and bad odours when the appliance is switched off.

Version

6 models, different in size, performance and supply, also available in versions with timer and relative humidity sensor.

Technical features

- White, shock-proof, plastic resin (ABS) casings prevent ageing caused by exposure to sunlight ("UV resistant").
- Recessed boxes in black plastic resin (PP), loaded to give suitable resistance to the parts to be walled, rear exhaust, pre-set for side exhaust.
- 3-speed fan motors, obtained from the combination of:
 - Heat protected motors with shafts mounted on ball bearings to guarantee long lasting continuous service (at least 30,000 h) at the maximum plate temperature. Speed adjustment using Vortice accessory devices.
 - Forward-curved centrifugal impellers moulded in plastic resin, resistant to aggressive agents.
- 3-position speed selector, including ON/OFF command, compatible with wall and recessed box installation as per standard UNI 503.
- Dishwasher-safe air filters in PU.
- Non-return valves integrated on the exhaust ducts to prevent unwanted inflows of air and bad odours when the appliance is switched off.
- T models equipped with electronic timer for automatic product switch-off after a pre-fixed period of time, which can be set in the installation phase, from 3'-20' (default setting 3').
- T-HCS models equipped with circuit board with relative humidity sensor (RH), adjustable to 4 predefined threshold levels (60%, 70%, 80%, 90 %), alternatively can be set during installation, which determines automatic fan activation. The board integrates an electronic timer for automatic shut-down of the product after return to a RH below the pre-set threshold. The duration of the timer can be set at installation within the interval 3'-20' (default setting 3').
- Performance and safety certified by third party body (IMQ)
- Class of electric isolation: II □ (earthing not required).



RANGE

	BASE	TIMER	TIMER HCS
MICRO 100 I	12017 MICRO 100 I 12045 MICRO 100 I ES	12018 MICRO 100 I T 12046 MICRO 100 I T ES	12065 MICRO 100 I T HCS
MEDIO I	12020 MEDIO I	12021 MEDIO I T	12066 MEDIO I T HCS
SUPER I	12023 SUPER I	12024 SUPER I T	12067 SUPER I T HCS



TECHNICAL DATA

MODELS	V~50HZ	W min/max	A min/max	RPM min/max	MAX AIRFLOW		MAX PRESSURE		Lp dB(A) 3m min/max	MAX °C	KG
					m³/h min/max	l/s min/max	mmH₂O min/max	Pa min/max			
MICRO 100 I	220-240	20 27	0,10 0,12	1010 1450	75 100	21 28	20 22	196 218	26,3 34,3	50	1,91
MICRO 100 I ES	220-240	8 15	0,08 0,12	1090 1430	75 100	21 28	9 18	88 177	31,8 38,4	50	1,91
MEDIO I	220-240	25 29	0,14 0,18	1150 1890	70 122	19 34	21 34	206 331	35,9 41,2	50	2,8
SUPER I	220-240	50 115	0,36 0,50	1280 2190	140 285	38 79	20 48	196 476	33,6 46,7	50	4,27



RESIDENTIAL VENTILATION

VORT QUADRO I RANGE

VORT QUADRO I RANGE | TECHNICAL DATA FOR REGULATION N° 1254/2014/UE

	UNIT OF MEASURE	MICRO 100 I	MEDIO I
Supplier's name or trade mark	-	Vortice	Vortice
Specific Energy Consumption class SEC in average climate zone	-	NA	NA
Specific Energy Consumption class SEC average	-	-15,0	-14
Specific Energy Consumption class SEC cold	kWh/m ² year	-1,7	-1
Specific Energy Consumption class SEC warm	-	6,0	7
Declared typology	-	RVU-U*	RVU-U*
Type of drive	-	NA	MSD
Type of heat recovery system HRS	-	none	none
Thermal efficiency of heat recovery at reference air flow	%	NA	NA
Maximum flow rate	m ³ /h	100	106
Electric power input of the fan drive, including any motor control equipment, at maximum flow rate	W	27,0	29,6
Sound power level LWA	LWA [DB(A)]	54	62
Reference flow rate	m ³ /s	0,0194	0.02944
Reference pressure difference	Pa	95	196
SPI	W/(m ³ /h)	0.35714	0.384
Control factor CTRL	-	1	1
Control typology	-	manual	manual
Maximum internal leakage rates	%	NA	NA
Maximum external leakage rates	%	NA	NA
Mixing rate	-	NA	NA
Position and description of visual filter warning	-	NA	NA
Airflow sensitivity to pressure variations at + 20 Pa and – 20 Pa	-	NA	0,06
Indoor/outdoor air tightness	m ³ /h	NA	NA
Annual electricity consumption (AEC)	kWh electricity/year	492	529
AHS average Annual heating saved	-	1397	1397
AHS cold Annual heating saved	kWh primary energy/year	2732	2732
AHS warm Annual heating saved	-	632	632

* RVU-U: Unit Ventilation Residential - Unidirectional - **NRVU-U: Unit Ventilation Non Residential - Unidirectional - ***MSD: Multi-Speed Drive - NA: Not applicable

VORT QUADRO I AC RANGE | TECHNICAL DATA FOR REGULATION N° 1254/2014/UE

	UNIT OF MEASURE	SUPER I
Supplier's name or trade mark	-	Vortice
Declared typology	-	NRVU-U**
Type of drive	-	VSD***
Type of heat recovery system HRS	-	None
Thermal efficiency of heat recovery	-	NA
Nominal NRVU flow rate	m ³ /s	0,05833
Effective electric power input	kW	0,095
SFPint	W/(m ³ /h)	NA
Face velocity at design flow rate	m/s	7,894
Nominal external pressure (Δps,int)	Pa	205
Internal pressure drop of ventilation components (Δps,int)	Pa	245
Internal pressure drop of non-ventilation components (Δps,int)	Pa	0
Static efficiency of fans used in accordance with Regulation (EU) N. 3272011	%	27,6
Declared maximum internal leakage rate of the casing of ventilation units	%	NA
Declared maximum external leakage rate of the casing of ventilation units	%	NA
Energy performance energy or classification of the filters	-	NA
Description of visual filter warning	%	NA
Casing sound power level (LWA)	dB(A)	67

* RVU-U: Unit Ventilation Residential - Unidirectional - **NRVU-U: Unit Ventilation Non Residential - Unidirectional - ***VSD: Variable-Speed Drive



DIMENSIONS

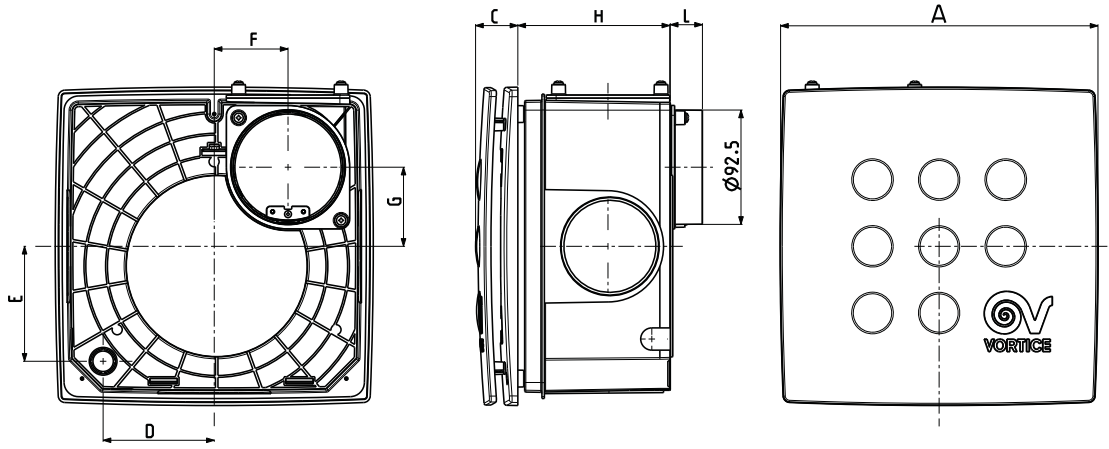

MODELS	A	C	D	E	F	G	H	L
MICRO 100 I	258	34	92	90	64	60	118	26
MICRO 100 I ES	258	34	92	90	64	60	118	26
MEDIO I	287	37	97	103	72	69	130	26

Dimensions (mm)

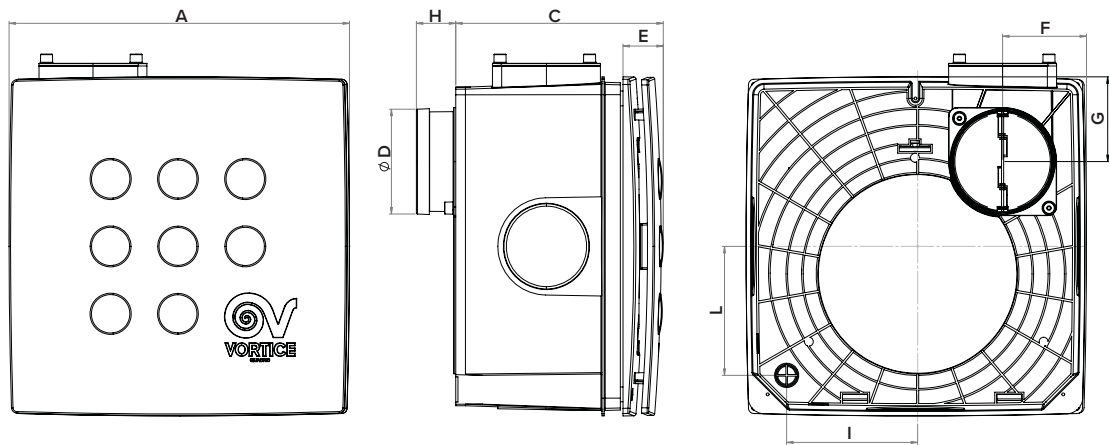

MODELS	A	C	D	E	F	G	H	I	L
SUPER	314	190	97	37	76	79	37	120	120

Dimensions (mm)



RESIDENTIAL VENTILATION

VORT QUADRO I RANGE

PERFORMANCE CURVES

MICRO 100 I

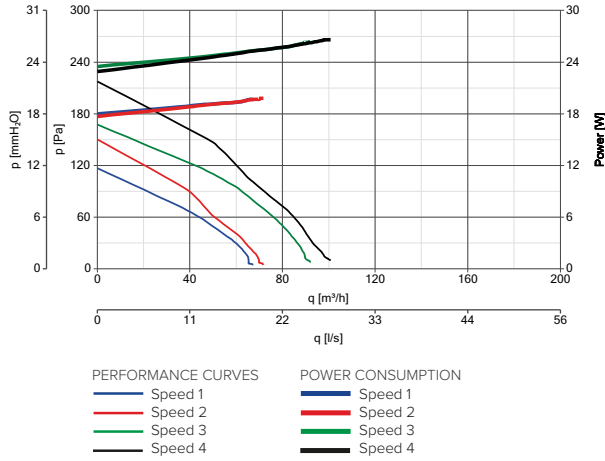

MICRO 100 I ES

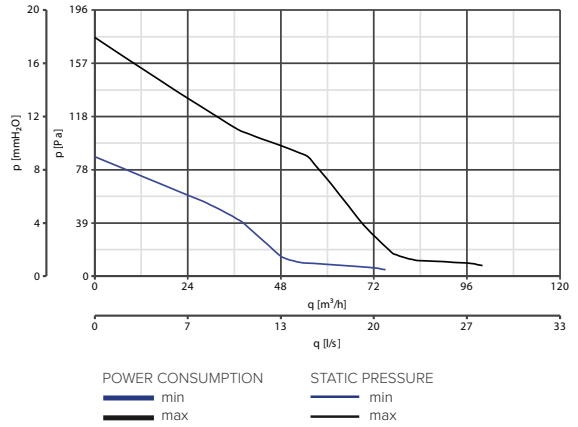

MEDIO I

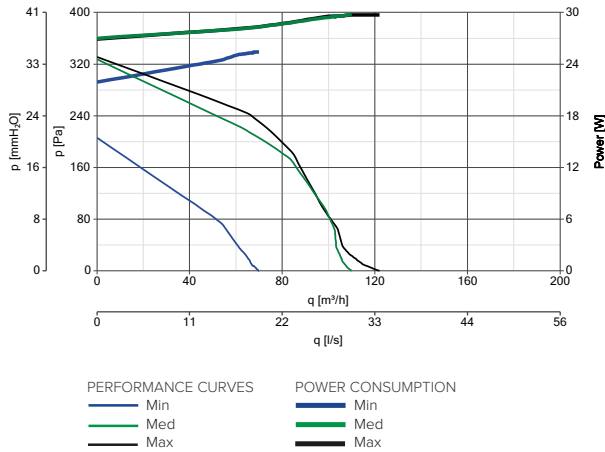



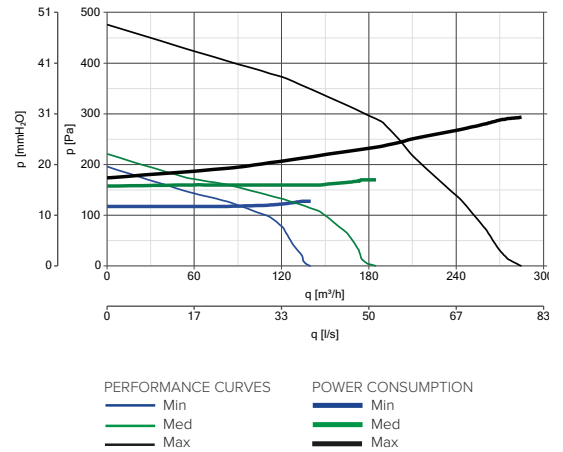

SUPER I







CONTROLLER

MODELS	DESCRIPTION	CODE	PRODUCT
	C 1.5 - RElectronic speed controller 1.5 A	12966	ALL PRODUCTS
	SCNRB - Electronic speed controller built-in	12971	ALL PRODUCTS
	SCB KIT - Built-in controller adaptor for C 1.5	22481	12966
	TRIO-S - Built-in controller adaptor for C 1.5	12871	12023 - 12024 -12067

ACCESSORIES ON REQUEST

MODELS	DESCRIPTION	CODE	PRODUCT
	AIR DEFLECTOR	100/4 22310	ALL PRODUCTS
	CEILING KIT	MICRO 100 I 22491	12017 - 12045 - 12018 - 12046 - 12065
		MEDIO I 22492	12020 - 12021 - 12066
		SUPER I 22493	12023 - 12024 - 12067

APPLICATIONS





VORT QUADRO EVO RANGE

Residential centrifugal extractor fans

Wall, ceiling and recess mounted centrifugal extractors for ventilation of residential and commercial premises whose pan view imposes ducting of the exhaust. Designed in compliance with the German DIN 18017-3 Standard, which imposes strict fire propagation resistance requirements., They are characterised by the excellent balance between performance and consumption and for the very low noise emissions.

Key features

- Very low noise emissions, guaranteeing comfortable use
- 1, 2 or 3-speed fan motors, depending on the model, designed to combine high performance and low power consumption
- Sophisticated electronic equipment to meet a particularly wide range of application needs.
- Closed front panels that confer a modern image to the product and facilitate cleaning.
- Reduced exhaust sleeve depth, compatible with installation immediately upstream of a 90° bend.
- Decentralised exhaust which, with the 360° adjustable front panels, amplify the range of possible installations
- Protection from dust and water jets exceeds the requirements of use in Zone 1 bathroom installations.
- Modular configuration to configure the product according to requirements.
- Dishwasher-safe filters.
- TUV certified sealed non-return valves that prevent unwanted inflows of air and bad odours when the device is switched off.
- TUM certified fire propagation resistance (K90 valves and K90 recessed boxes)

Version

23 models, different due to performance and supplies, also available in versions with timer, with advanced timer, with advanced timer coupled with the relative humidity sensor and with presence sensor. The modular design of this range also allows a very large amount of different product combinations to be achieved by suitably combining the 23 alternative fan motor groups and the 10 different containment casings offered separately, in a way to meet a particularly wide range of application requirements.



VENTILATION UNITS:

23 models different for electronic Suite (5)
and level of performance (5)

CASINGS EXTERNAL/RECESSED MOUNTINGS:

10 casings, different for installation
and fire protection grade



Technical features

Fan Motor units composed of:

- 1, 2 or 3 speed heat-protected motor, depending on the model, with shafts mounted on ball bearings to guarantee long lasting (at least 30,000 h) continuous service at the maximum plate temperature.
- Forward-curved centrifugal impeller, in plastic resin (PBT) which combines high rigidity and dimensional stability with great resistance to aggressive chemical agents. Its high efficiency, resulting from accurate aerodynamics studies, along with the scroll that encloses it, guarantees high pressure levels at a wide range of air flows supplied.
- Scroll, including the circuit board housing in self-extinguishing (V0)ABS.
- Aesthetic front panel in self-extinguishing (V0)ABS, which confers a modern image to the product and facilitates cleaning. The hinge that fastens it to the underlying motor-holder, allows a wide angle of rotation to facilitate the periodic cleaning interventions.
- Motor-holder in ABS.
- Filter support in ABS.
- Air filter, including a saturated filter warning device.
- Control electronics.

The wall and recess version boxes include outlet spigot with nominal diameter 80 mm, complete with sealed non-return valve (compliance with DIN 18017-3 Standard certified by TÜV). Every recessed box is complete with relevant frame, which prevents the entry of dirt or plaster during installation. The VORT QUADRO EVO range envisions:

- Boxes for standard external (wall or ceiling) and recessed installation, without specific fire resistance requirements. The recessed boxes are set-up for connection to a vent that allows extraction from a second adjacent room.
- Boxes for external (wall or ceiling) and recessed installation equipped with class K90 fire shutter, certified by the German TUM body in compliance with reg. DIN 18017-3. These components, intended for installation outside the ventilation duct, are expressly designed to prevent the propagation of fire to other apartments in the building through the shared exhaust duct, if there is a fire in the serviced room.
- Recessed boxes, certified by the German TUM body in compliance with reg. DIN 18017-3, characterised by class K90 refractory, fire-proof casing and equipped with class K90 fire shutter. These components, intended for installation inside the ventilation duct, are expressly designed to prevent the propagation of fire to other apartments in the building through the shared exhaust duct, if there is a fire in the serviced room.
 - Safety certified by IMQ
 - Performance and sealing of the non-return valves tested by TÜV
 - Fire resistance of the valves K90 and the casings K90 certified by TUM
 - Protection rating from dust and water: IP45
 - Class of electric isolation: II □ (earthing not required).



Excellent sealing of backdraught shutter (TÜV Certified), to prevent the risk of bad smells and cold air diffusion when the product is switched off.





ALTERNATIVE OPERATING MODES

The VORT QUADRO EVO range offers a wide range of functional alternatives, depending on the degree of sophistication of the electronics used; select the most suitable for the specific requirements, in particular:

Base versions

- Switch product on/off using an external switch, which may coincide with the light switch.
- The change in performance (in the case of multi-speed products), is made using the external switch.
- In the case of multi-speed devices, on installation, it is also possible to have continuous product operation at minimum speed (Continuous Ventilation of the serviced room), boosting it to a higher speed by the activation of the external switch (Boost function).

Timer versions

- The fan is started/stopped using the external switch coinciding with the light control of the serviced room; on installation, the control electronics allow programming of delayed fan start/stop with respect to switch-on/switch-off the light; they can be respectively set at 0 or 45 seconds and between 0 and 20 minutes.
- The change in performance (in the case of multi-speed products), is made using the external switch.
- In the case of multi-speed devices, on installation, it is also possible to have continuous product operation at minimum speed (Continuous Ventilation of the serviced room), boosting it to a higher speed by switch-on/off of the light switch (Boost function), without jeopardising the possibility to set, on installation, the delays described in the previous point.

Advanced timer version (TP)

- The fan is started/stopped using the external switch coinciding with the light control of the serviced room; on installation, the control electronics allow programming of a delayed appliance start/stop with respect to switch-on/switch-off the light; they can be respectively set at 0, 45, 90 or 120 seconds and between 6, 10, 15 or 21 minutes.
- In the case of multi-speed devices, on installation, it is also possible to have continuous product operation at minimum speed (Continuous Ventilation of the serviced room), boosting it to a higher speed by switch-on/off of the light switch (Boost function), without jeopardising the possibility to set, on installation, the delays described in the previous point.
- Alternatively, in multi-speed models, it is possible upon installation to set device start at min speed immediately after the light is switched-on (COMFORT function) and automatic switch-over at max speed when the light is switched-off and, finally, shut-down after 6, 10, 15 or 21 minutes.
- Finally, to ensure correct ventilation of the serviced room even in the event of prolonged periods of non-use (HOLIDAY function), it is possible to program periodic every 8, 12 or 24 h product start up cycles at durations that can be set at 6, 10, 15 or 21 minutes.

Advanced timer + Relative Humidity sensor versions (TP + HCS)

- Advanced timer mode: the fan is started/stopped using the external light switch of the environment; on installation, the control electronics allow programming of a delayed appliance start/stop with respect to switch-on/switch-off the light; they can be respectively set at 0, 45, 90 or 120 seconds and between 6, 10, 15 or 21 minutes.
- HCS mode: product start/stop depends on the degree of relative humidity (RH) detected by the HCS sensor (Humidity Control System) integrated into the control electronics, which operates according to two distinct criteria, to ensure the best environmental conditions in the premises:
 - Exceeding the threshold: the product starts automatically when the RH threshold is exceeded; it can be set on installation at 60%, 70%, 80% or 90%. It stops automatically when the RH drops 15% below the threshold pre-set or after 2 hours of uninterrupted operation.
 - Quick increase of the level of RH: the product starts automatically as a result of a sudden RH increase (> 20% in 10 minutes), stopping immediately when the RH falls below 15% of the initial value or after 2 hours of uninterrupted operation.

Connection to external control is also envisioned to make fan operation independent from the RH concentration (e.g. to prevent undesired switch-on in the presence of particularly high outdoor air RH levels).

In the case of multi-speed appliances, on installation, it is also possible to have continuous product operation at minimum speed (Continuous Ventilation of the serviced room), boosting it to a higher speed by the switch-on/off of the light switch, i.e. the readings of the RH sensor (Boost function), without jeopardising the setting alternatives described above.

Timer + presence sensor version (T + PIR)

- The fan starts immediately when the IR ray presence sensor (PIR - Passive Infra Red) detects occupants in the room. It stops with a delay between 0' and 20', which is set at switch-on, after the occupants have left the room.
- In the case of multi-speed appliances, on installation, it is also possible to have continuous product operation at minimum speed (continuous ventilation of the serviced room), boosting it to a higher speed by the activation of occupants presence detection (Boost function), without jeopardising the possibility to set the switch-off delay on installation, described in the previous point.



TECHNICAL DATA

Referred to Max, Mid, Min speed when available

MODELS	CODE	V~50HZ	W min/med/ max	A min/med/ max	RPM min/med/ max	MAX AIRFLOW		MAX PRESSURE		MAX °C*	KG
						m³/h min/med/max	l/s min/med/max	mmH₂O min/med/max	Pa min/med/max		
QE 60 LL	11521										
QE 60 LL T	11526										
QE 60 LL TP	11532	220 - 240	16	0.14	1170	60	16.7	35	343	50	2.33
QE 60 LL TP HCS	11537										
QE 60 LL T PIR	11544										
QE 60/35 LL	11523										
QE 60/35 LL T	11528										
QE 60/35 LL TP	11534	220 - 240	9 16	0.11 0.14	855 1170	35 60	9.7 16.7	10 35	98 343	50	2.33
QE 60/35 LL TP HCS	11541										
QE 60/35 LL T PIR	11546										
QE 100 LL	11522										
QE 100 LL T	11527										
QE 100 LL TP	11533	220 - 240	26	0.17	1570	100	27.8	36	353	50	2.33
QE 100 LL TP HCS	11538										
QE 100 LL T PIR	11545										
QE 100/60 LL	11524										
QE 100/60 LL T	11531										
QE 100/60 LL TP	11535	220 - 240	16 26	0.14 0.17	1170 1570	60 100	16.7 27.8	35 36	343 353	50	2.33
QE 100/60 LL TP HCS	11542										
QE 100/60 LL T PIR	11547										
QE 100/60/35 LL	11525										
QE 100/60/35 LL TP	11536	220 - 240	9 16 26 9	0.11 0.14 0.17	855 1170 1570	35 60 100	9.7 16.7 27.8	10 35 36	98 343 353	50	2.33
QE 100/60/35 LL TP HCS	11543										

SOUNDS LEVELS

SOUND POWER LwA							
Airflow m³/h	WALL MOUNTING			Airflow m³/h	RECESSED MOUNTING		
	100	60	35		100	60	35
dB(A)	50.5	43.7	33.7	dB(A)	50.2	42	32.7

SOUND PRESSURE* Lp dB(A) 2m							
Airflow m³/h	WAL MOUNTING			Airflow m³/h	INSTALLAZIONE A INCASSO		
	100	60	35		100	60	35
dB(A)	39.0	32.2	22.2	dB(A)	38.7	30.5	21.2



RESIDENTIAL VENTILATION

VORT QUADRO EVO RANGE

CASING

Casings integrate a nominal 80 mm diameter spigot and a backdraught shutter. Casings are also provided with a frame to prevent entry of dirt and plaster.

BASIC FOR INSTALLATION ON WALLS AND CEILINGS

	CODE	MODEL	DESCRIPTION
	11561	QE - B M	Basic encasement for surface (wall/ceiling) installation, made of ABS plastic. Spigot made of ABS plastic, integrating the backdraught shutter compliant with DIN 18017-3, as certified by TUV German Institute.

BASIC FOR INSTALLATION ON WALLS AND CEILINGS WITH FIREPROOF (CLASS K90), BACKDRAUGHT SHUTTER

	CODE	MODEL	DESCRIPTION
	11563	QE - B M VK90	Basic encasement for surface (wall/ceiling) installation, made of ABS plastic. Stainless steel spigot, integrating the K90 fireproof valve, TUM certified according to DIN 18017-3. Backdraught shutter compliant with DIN 18017-3, as certified by TUV German Institute.

BASIC FOR RECESSED INSTALLATION

	CODE	MODEL	DESCRIPTION
	11560	QE - B I	Basic encasement for recessed installation, made of ABS plastic. Spigot made of ABS plastic, integrating the backdraught shutter compliant with DIN 18017-3, as certified by TUV German Institute. Square frame to prevent entry of dirt and plaster. Port to connect a spigot (QE-AD cod. 21118, available as accessory) to extract air from a second room. Possibility of drywall installation.







BASIC FOR RECESSED INSTALLATION WITH FIREPROOF CLASS K 90, BACKDRAUGHT SHUTTER

	CODE	MODEL	DESCRIPTION
	11562	QE - B I VK90	Basic encasement for recessed installation, made of ABS plastic. Stainless steel spigot, integrating the K90 fireproof valve, TUM certified according to DIN 18017-3. Backdraught shutter compliant with DIN 18017-3, as certified by TUV German Institute. Square frame to prevent entry of dirt and plaster. Port to connect a spigot (QE-AD cod. 21118, available as accessory) to extract air from a second room. Possibility of drywall installation.



RECESSED MOUNTINGS

RECESSED INSTALLATION FIREPROOF ENCASEMENT K 90, WITH FIREPROOF CLASS K 90 BACKDRAUGHT SHUTTER

	CODE	MODELS	DESCRIPTION
	11564	QE - B I K90 R	Fireproof K90 casing for recessed installation and rear discharge. Stainless steel spigot, integrating the K90 fireproof valve, TUM certified according to DIN 18017-3. Backdraught shutter compliant with DIN 18017-3, as certified by TUV German Institute Spigot nominal diameter: 80 mm. Square frame to prevent entry of dirt and plaster.
	11565	QE - B I K90 S	Fireproof K90 casing for recessed installation and side discharge. Stainless steel spigot, integrating the K90 fireproof valve, TUM certified according to DIN 18017-3. Backdraught shutter compliant with DIN 18017-3, as certified by TUV German Institute Spigot nominal diameter: 80 mm. Square frame to prevent entry of dirt and plaster.
	11566	QE - B I K90 R 2R	Fireproof K90 casing for recessed installation and rear discharge. Stainless steel spigot, integrating the K90 fireproof valve, TUM certified according to DIN 18017-3. Backdraught shutter compliant with DIN 18017-3, as certified by TUV German Institute Spigot nominal diameter: 80 mm. Square frame to prevent entry of dirt and plaster. Stainless steel spigot, on the right side, able to extract air from a second room.
	11567	QE - B I K90 R 2L	Fireproof K90 casing for recessed installation and rear discharge. Stainless steel spigot, integrating the K90 fireproof valve, TUM certified according to DIN 18017-3. Backdraught shutter compliant with DIN 18017-3, as certified by TUV German Institute Spigot nominal diameter: 80 mm. Square frame to prevent entry of dirt and plaster. Stainless steel spigot, on the left side, able to extract air from a second room.
	11568	QE - B I K90 S 2R	Fireproof K90 casing for recessed installation and side discharge. Stainless steel spigot, integrating the K90 fireproof valve, TUM certified according to DIN 18017-3. Backdraught shutter compliant with DIN 18017-3, as certified by TUV German Institute Spigot nominal diameter: 80 mm. Square frame to prevent entry of dirt and plaster. Stainless steel spigot, on the right side, able to extract air from a second room.
	11569	QE - B I K90 S 2L	Fireproof K90 casing for recessed installation and side discharge. Stainless steel spigot, integrating the K90 fireproof valve, TUM certified according to DIN 18017-3. Backdraught shutter compliant with DIN 18017-3, as certified by TUV German Institute. Spigot nominal diameter: 80 mm. Square frame to prevent entry of dirt and plaster. Stainless steel spigot, on the left side, able to extract air from a second room.



RESIDENTIAL VENTILATION

VORT QUADRO EVO RANGE

DIMENSIONS

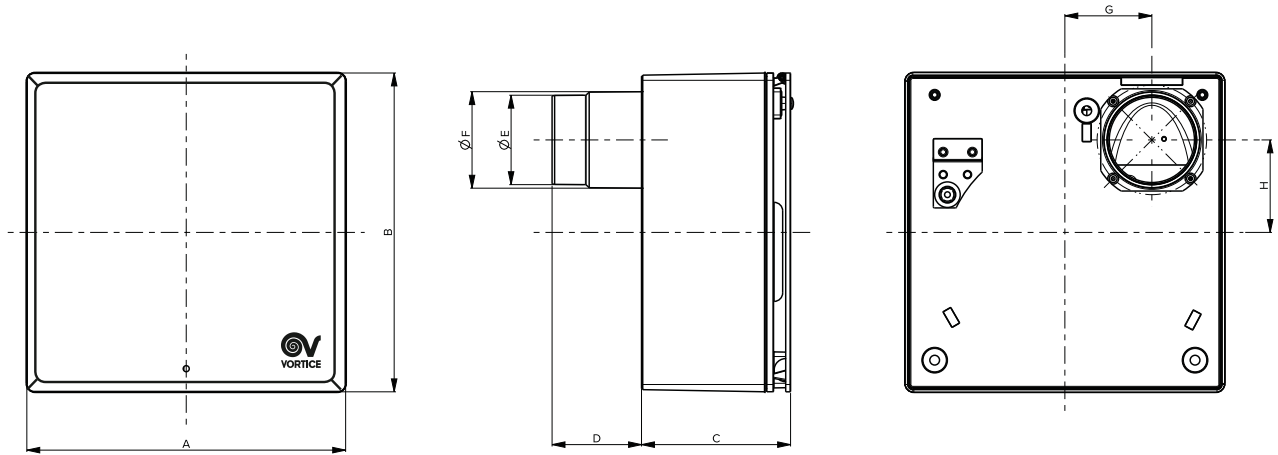

SURFACE MOUNTED VERSION

A	B	C	D	Ø E	Ø F	G	H
262	262	111,5	80	73	79	71,5	90

Dimensions (mm)

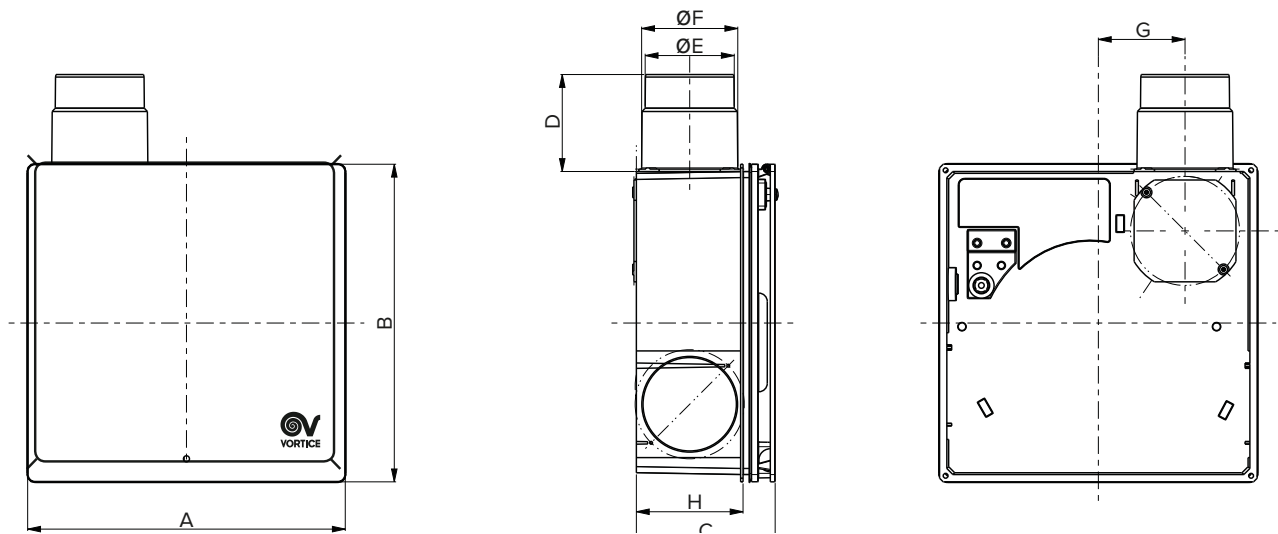

RECESSED VERSION

A	B	C	D	Ø E	Ø F	G	H
262	262	115,5	80	73	79	71,5	90

Dimensions (mm)



PERFORMANCE CURVES

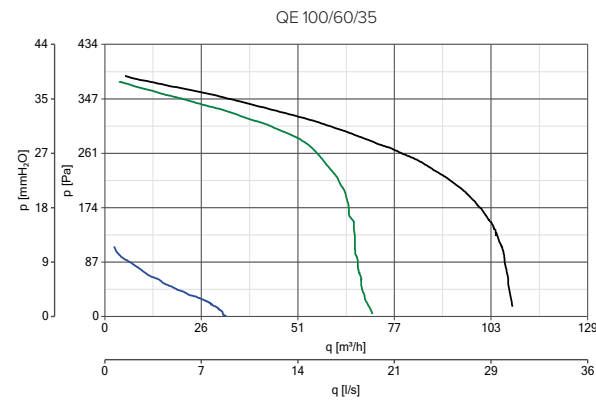
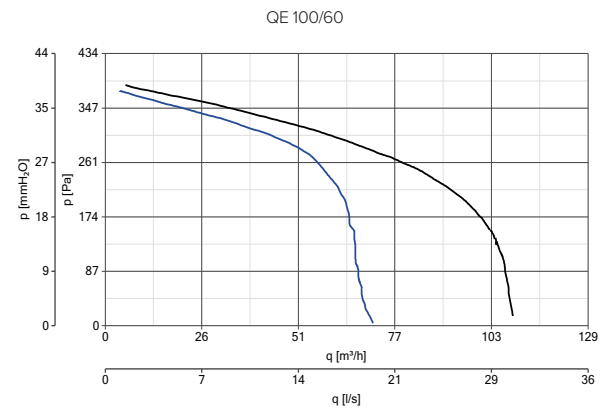
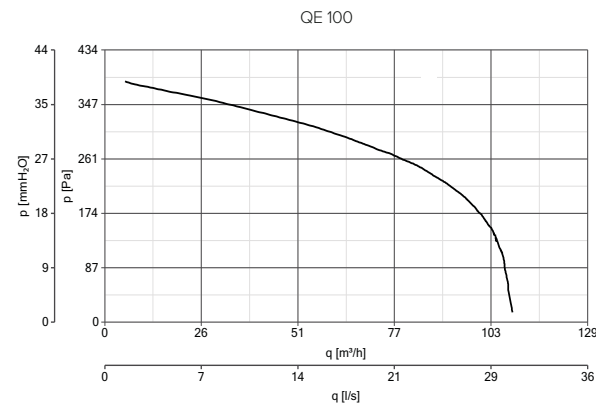
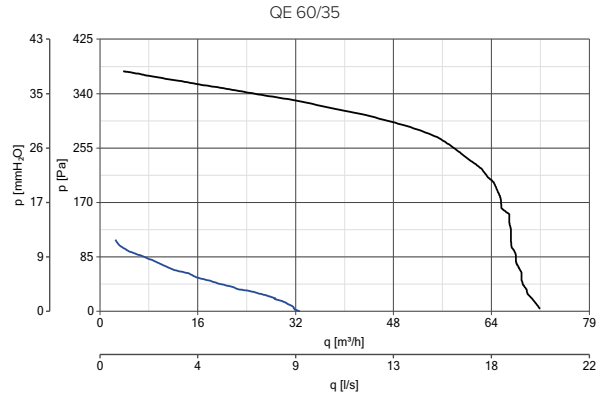
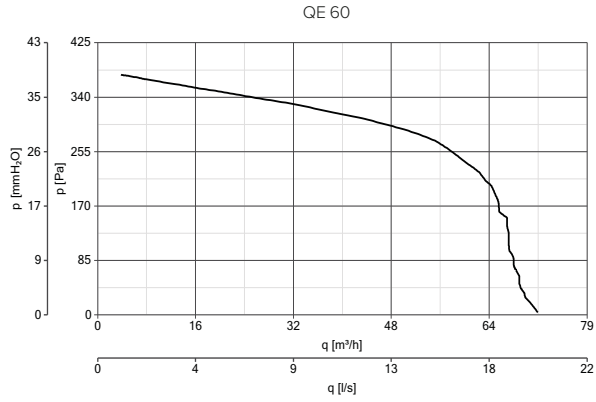



- MAX speed
- MID speed
- MIN speed













RESIDENTIAL VENTILATION

VORT QUADRO EVO RANGE

CONTROLLER





MODELS	DESCRIPTION	CODE	PRODUCT
	3SS - D - 2 - 3 speeds switch for flush mounted installation, in a DIN Standard box	21132	11560 - 11561 - 11562 - 11563
	2SS - I - 2 speeds switch for flush mounted installation, in a UNI 503 Standard box	21133	11560 - 11561 - 11562 - 11563
	3SS - I - 3 speeds switch for flush mounted installation, in a UNI 503 Standard box	21134	11560 - 11561 - 11562 - 11563

ACCESSORIES ON REQUEST

MODELS	DESCRIPTION	CODE	PRODUCT
	QE - MH - Mounting holder for flush mounting in plasterboard systems	24127	11560 - 11562
	QE - TEK - Toilet extraction kit for WC	24128	11560 - 11562
	QE - UMB - Universal bracket for flush mounting in duct systems and false ceilings also for fireproof K90 casings	24094	11560 - 11562
	QE - SRK - Second room kit (including second room spigot)	24129	11560 - 11562
	QE FBA - Plasterboard adapter	24183	11560 - 11562
	QE - AD - Second room spigot	21118	11560 - 11562
	QE - CFR - Plasterboard cover	24229	11560 - 11562
	QE - SPF - Space frame	21101	11560 - 11562
	SWAG - White door grille	21119	11560 - 11561 - 11562 - 11563
	SABG - Brown door grille	21120	11560 - 11561 - 11562 - 11563



ACCESSORIES ON REQUEST

MODELS	DESCRIPTION	CODE	PRODUCT
	AVR 100 mm	21121	11560 - 11561 - 11562 - 11563
	AVR 125 mm	21122	11560 - 11561 - 11562 - 11563
	AVR 140 mm	21123	11560 - 11561 - 11562 - 11563
	AVR 160 mm	21124	11560 - 11561 - 11562 - 11563
	AVR 180 mm	21125	11560 - 11561 - 11562 - 11563
	AVR 200 mm	21126	11560 - 11561 - 11562 - 11563
	MDV 100 - Manual air supply valve for 100 mm duct	21127	11560 - 11561 - 11562 - 11563
	ADV 100 - Automatic air supply valve for 100 mm duct	21128	11560 - 11561 - 11562 - 11563
	MSDV 100 - Manual air supply valve for 100 mm duct, with sound insulation	21129	11560 - 11561 - 11562 - 11563
	ASDV 100 - Automatic air supply valve for 100 mm duct, with sound insulation	21130	11560 - 11561 - 11562 - 11563

APPLICATIONS



60 m³/h BATHROOM OR TOILETS

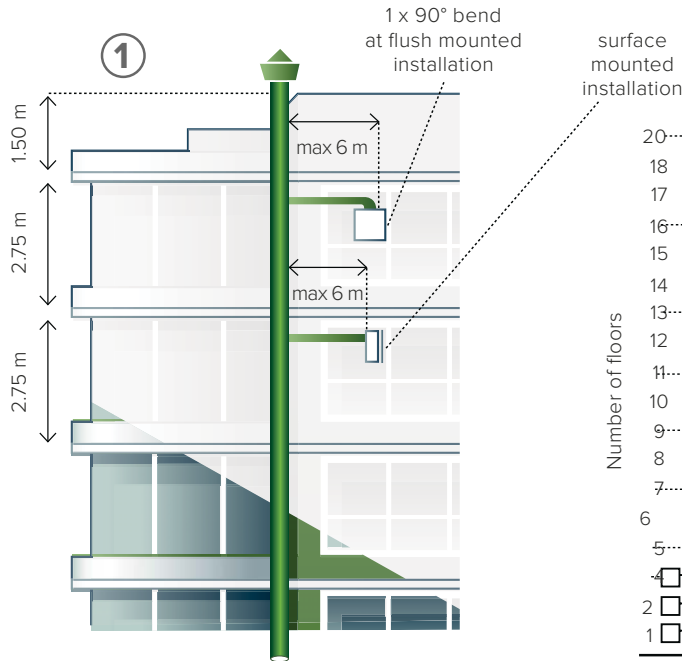

INSTALLATION OF 1 UNIT PER FLOOR

With 60 m³/h designed air flow volume and operation of all units at the same time.

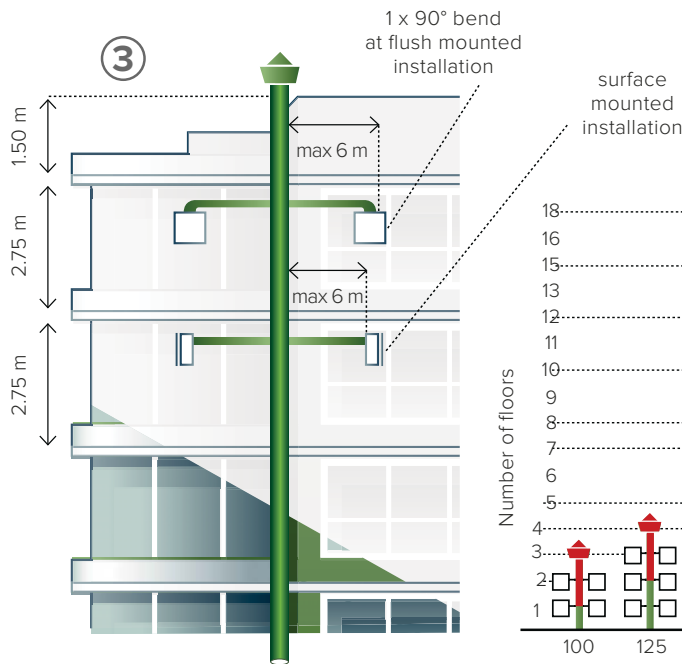
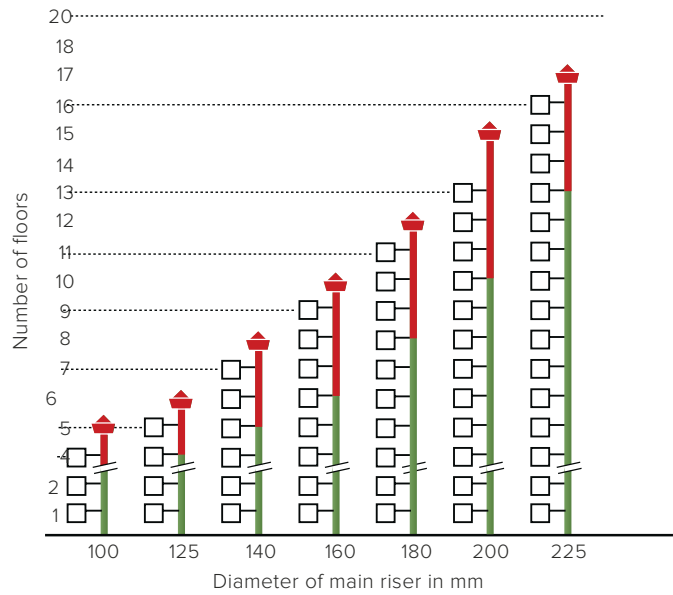

INSTALLATION OF 2 UNITS PER FLOOR

With 60 m³/h designed air flow volume and operation of all units at the same time.

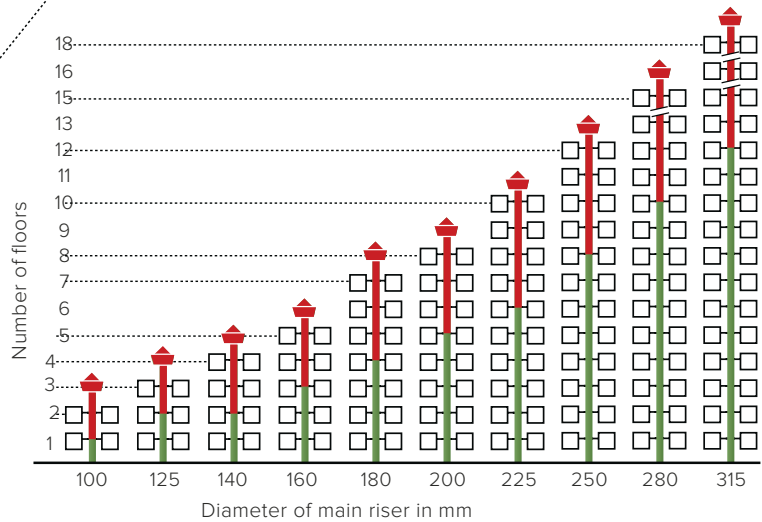

Reference room height 2.75 m; straight ducting without bends; ducting length max. 1.5 m from last unit to air extract above the roof max pressure loss between ventilated room and exhaust opening 60 Pa. The required main riser diameter can be read from above diagram. Data valid for operated at nominal air flow volumes of 60 or 100 m³/h per unit and all units operated at the same time. Copies of approvals are available on request.

◆ These number of floors are outside of comfort range, therefore non recommendable.

Example 1
Type of room: bathroom/toilet
V = 60 m³/h

Units per floor: 1
Floor levels: 5
Main riser diameter: 125 mm



100 m³/h ONE AND TWO ROOM VENTILATION

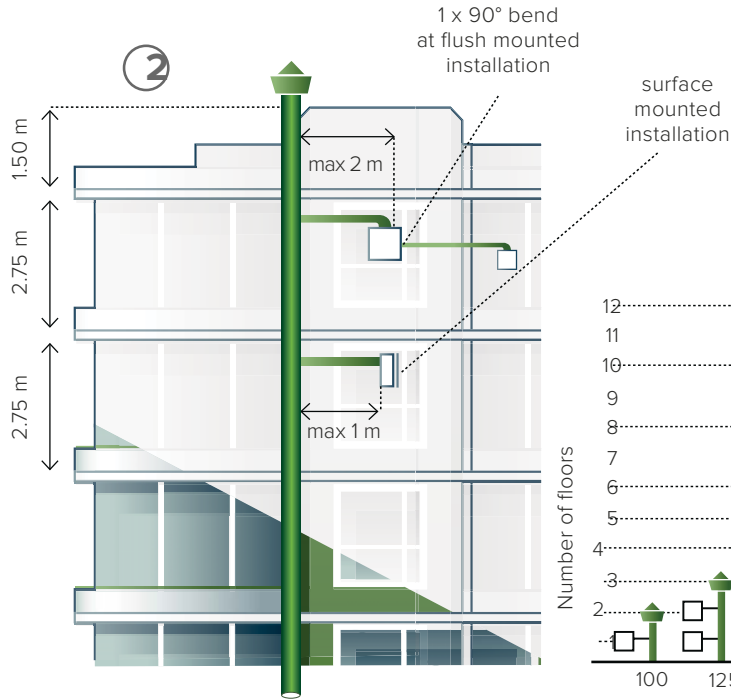

INSTALLATION OF 1 UNIT PER FLOOR

With 100 m³/h designed air flow volume and operation of all units at the same time. (Volume e.g. = 100 m³/h. Second room ventilation with one unit = bathroom 60 m³/h, toilet 35 m³/h)

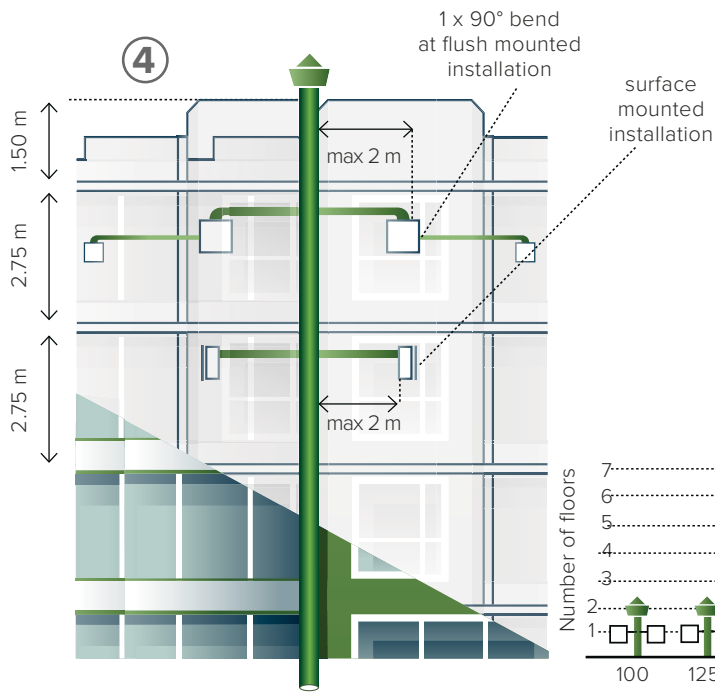
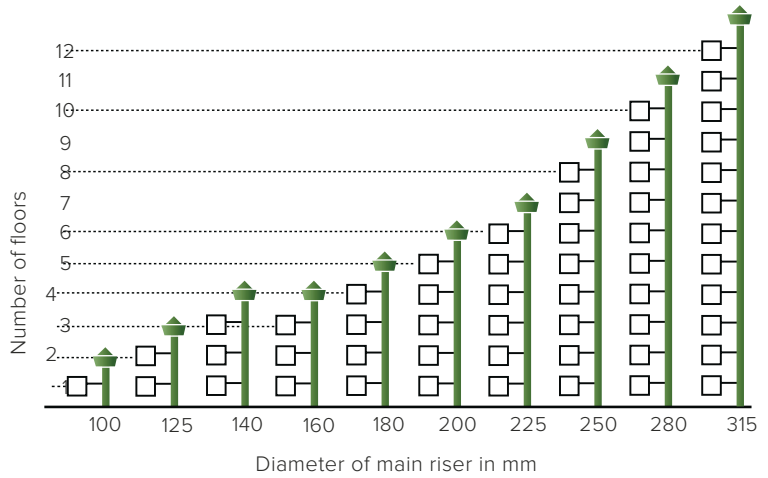

INSTALLATION OF 2 UNITS PER FLOOR

With 100 m³/h designed air flow volume and operation of all units at the same time. (Volume e.g. = 100 m³/h. Second room ventilation with one unit = bathroom 60 m³/h, toilet 35 m³/h)

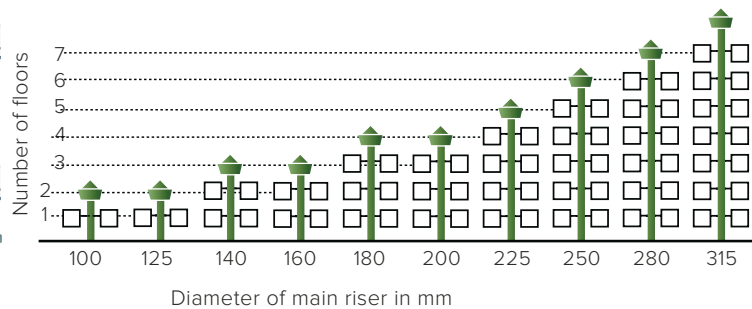

Example 2
 Type of room: bathroom + toilet (2 rooms) or kitchen
 V = 100 m³/h (bathroom 60 m³/h and toilet 35 m³/h)

Units per floor: 2
 Floor levels: 3
 Main riser diameter: 180 mm



VORT NOTUS RANGE

De-centralised continuous axial fans

Wall and ceiling axial fans compatible with in-line installation, ideal for continuous ventilation thanks to the very low consumption of the EC (brushless) motor used, in small and medium-size residential and commercial premises whose layout allows for direct exhaust or exhaust in short length pipes.

Key features

- Very reduced consumption thanks to the EC brushless, heat protected, 2-speed motor.
- Installation flexibility: remove the front panel and the underlying support flange to install the VORT NOTUS inside short length pipes.
- Modern design, in line with the latest trends, which combines aesthetic elegance with easy product cleaning and maintenance.
- Reduced thickness (approx. 40 mm) which minimises the aesthetic impact, and the protrusion is reduced to 22 mm when the front panel is removed (safety is however guaranteed by the elegant grille underneath).
- High protection from water, suitable for use in Zone 1 bathroom installations and in the presence of high relative humidity.



Version

2 models, with nominal diameter 100 mm, also in the timer version..

Technical features

- White, shock-proof, plastic resin (ABS) panels, prevents ageing caused by exposure to sunlight ("UV resistant").
- External rotor type EC (brushless) heat protected motors mounted on ball bearings to guarantee long lasting (at least 40,000 h) continuous service at the maximum plate temperature, characterised by very low consumption and able to deliver 3 different flow rates, 2 of which can be set as an alternative upon installation.
- Axial impellers with airfoil profile blades, optimised for combining high efficiency with low noise emissions.
- Performance and safety certified by third party body (IMQ)
- T-HCS model equipped with circuit board with relative humidity sensor (RH) which performs automatic switch-over from the previously set minimum flow rate to the maximum flow rate. The board integrates an electronic timer which resets minimum speed operation after the RH returns below the threshold value, with a delay that can be set at installation within the interval 3'-20 (default setting 3').
- Performance and safety certified by third party bodies (IMQ and BRE)
- Protection rating from dust and water: IPX4.
- Class of electric isolation: II \square (earthing not required).

TECHNICAL DATA

MODELS	CODE	V~50HZ	W min/max	A min/max	MAX AIRFLOW		MAX PRESSURE		Lp dB(A) 3m min/max	MAX °C	KG
					m ³ /h min/max	l/s min/max	mmH ₂ O min/max	Pa min/max			
VORT NOTUS	11903	220-230	1,5 2,8	0,018 0,025	11,7 42,0	3,3 11,7	2,4 8,8	23,5 86,3	10,1 17,3	50	0,80
VORT NOTUS T-HCS	11177	220	2,1 6,4	0,028 0,037	11,7 42,0	3,3 11,7	2,4 8,8	23,5 86,3	10,1 17,3	50	0,80

* Conforms with ISO 3744 for noise and pressure levels.



VORT NOTUS RANGE | TECHNICAL DATA FOR REGULATION N° 1254/2014/UE

	UNIT OF MEASURE	VORT NOTUS - VORT NOTUS T-HCS
Supplier's name or trade mark	-	Vortice
Specific Energy Consumption class SEC in average climate zone	-	NA
Specific Energy Consumption class SEC average	-	-6,2
Specific Energy Consumption class SEC cold	kWh/m ² year	-19,5
Specific Energy Consumption class SEC warm	-	1,5
Declared typology	-	RVU-U*
Type of drive	-	NA
Type of heat recovery system HRS	-	none
Thermal efficiency of heat recovery at reference air flow	%	NA
Maximum flow rate	m ³ /h	43
Electric power input of the fan drive, including any motor control equipment, at maximum flow rate	W	3,5
Sound power level LWA	LWA [DB(A)]	32,4
Reference flow rate	m ³ /s	0.0084
Reference pressure difference	Pa	62
SPI	W/(m ³ /h)	0.22591
Control factor CTRL	-	1
Control typology	-	manual
Maximum internal leakage rates	%	NA
Maximum external leakage rates	%	NA
Mixing rate	-	NA
Position and description of visual filter warning	-	NA
Airflow sensitivity to pressure variations at + 20 Pa and - 20 Pa	-	NA
Indoor/outdoor air tightness	m ³ /h	NA
Annual electricity consumption (AEC)	kWh electricity/year	311
AHS average Annual heating saved	-	1397
AHS cold Annual heating saved	kWh primary energy/year	2732
AHS warm Annual heating saved	-	632

* RVU-U: Unit Ventilation Residential - Unidirectional

** NRUVU-U: Unit Ventilation Non Residential - Unidirectional

*** MSD: Multi-Speed Drive

NA: Not applicable

DIMENSIONS

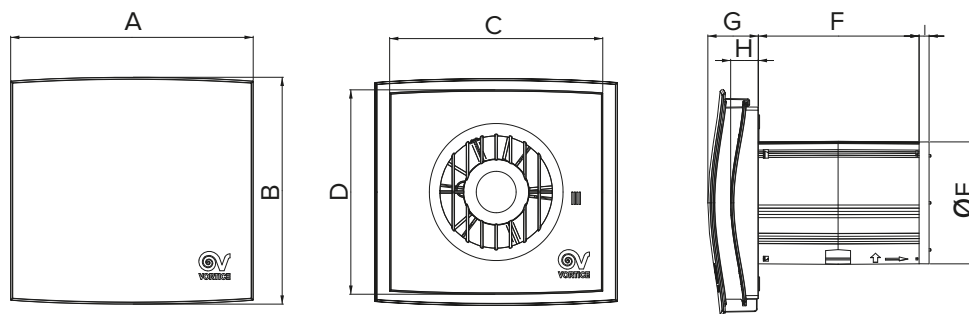

MODELS	A	B	C	D	ØE	F	G	H	I
VORT NOTUS	194,5	182	171	164	97,8	129	40,5	22,2	8
VORT NOTUS T-HCS	194,5	182	171	164	97,8	129	40,5	22,2	8

Dimensions (mm)



RESIDENTIAL VENTILATION

VORT NOTUS RANGE

PERFORMANCE CURVES

VORT NOTUS - VORT NOTUS T-HCS

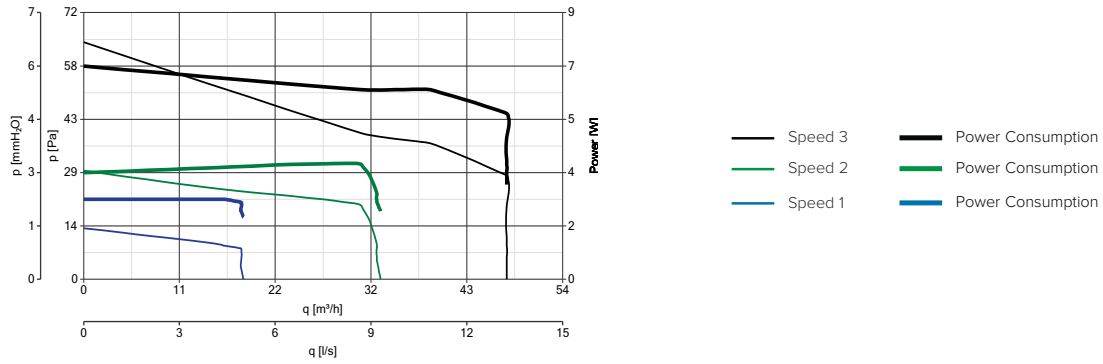

APPLICATIONS

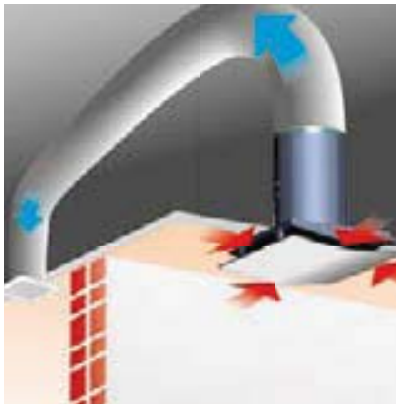









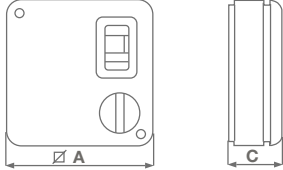

APPLICATIONS

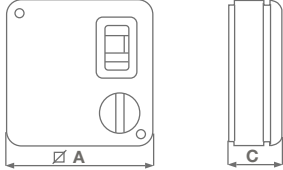

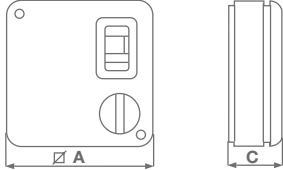

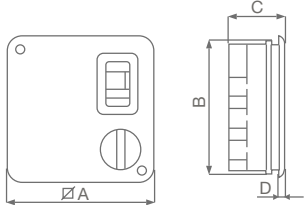

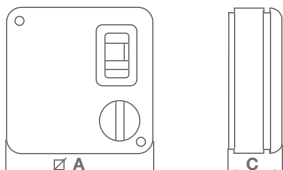



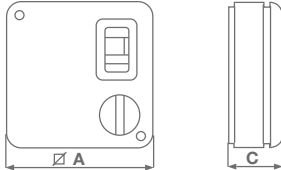

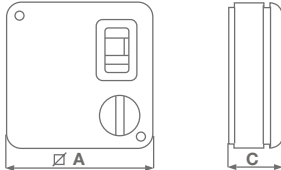
ACCESSORIES

MODELS	DESCRIPTION				CODE											
	C4VM16 - Four-speed selector, single phase <table border="1"> <thead> <tr> <th>MODELS</th> <th>∅ A</th> <th>C</th> </tr> </thead> <tbody> <tr> <td>C4VM16</td> <td>120</td> <td>55</td> </tr> </tbody> </table> Dimensions (mm)				MODELS	∅ A	C	C4VM16	120	55		14021				
MODELS	∅ A	C														
C4VM16	120	55														
	C3VM3 - Three speed selector, single phase <table border="1"> <thead> <tr> <th>MODELS</th> <th>∅ A</th> <th>C</th> </tr> </thead> <tbody> <tr> <td>C3VM3</td> <td>120</td> <td>43</td> </tr> </tbody> </table> Dimensions (mm)				MODELS	∅ A	C	C3VM3	120	43		12949				
MODELS	∅ A	C														
C3VM3	120	43														
	C 1.5 Non reversible variable electronic speed controller - Not suitable for products with timer or automatic shutters - Convertible to flush-mounted using SCB5 kit - Weight 0.2 Kg - Maximum load: 200 W (for C 1.5) - Double insulation <table border="1"> <thead> <tr> <th>MODELS</th> <th>∅ A</th> <th>C</th> </tr> </thead> <tbody> <tr> <td>C 1.5</td> <td>120</td> <td>43</td> </tr> </tbody> </table> Dimensions (mm)				MODELS	∅ A	C	C 1.5	120	43		12966				
MODELS	∅ A	C														
C 1.5	120	43														
	SCNRB Non reversible variable electronic speed controller (built-in) - Not suitable for products with timer or automatic shutters - Weight 0.2 Kg - Maximum load: 200 W - Double insulation <table border="1"> <thead> <tr> <th>MODELS</th> <th>∅ A</th> <th>B</th> <th>C</th> <th>D</th> </tr> </thead> <tbody> <tr> <td>SCNRB</td> <td>142</td> <td>135</td> <td>59.5</td> <td>4.5</td> </tr> </tbody> </table> Dimensions (mm)				MODELS	∅ A	B	C	D	SCNRB	142	135	59.5	4.5		12971
MODELS	∅ A	B	C	D												
SCNRB	142	135	59.5	4.5												
	C5 0.5 5 position speed controller - 5 speeds controller - Not suitable for timer, automatic, automatic timer and cord operated appliances - Convertible to flush-mounted using SCB5 kit - Weight 0.2 Kg - Double insulation Non reversible variable electronic speed controller (built-in) - Not suitable for products with timer or automatic shutters - Weight 0.2 Kg - Maximum load: 200 W - Double insulation <table border="1"> <thead> <tr> <th>MODELS</th> <th>∅ A</th> <th>C</th> </tr> </thead> <tbody> <tr> <td>C 1.5</td> <td>120</td> <td>43</td> </tr> </tbody> </table> Dimensions (mm)				MODELS	∅ A	C	C 1.5	120	43		12987				
MODELS	∅ A	C														
C 1.5	120	43														









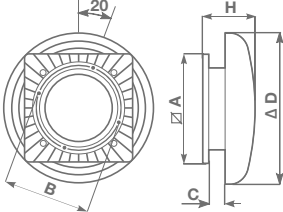

MODELS	DESCRIPTION		CODE									
	SPEED REGULATOR - Three-speed selector switch			22478								
	<table border="1"> <thead> <tr> <th>MODELS</th> <th>∅ A</th> <th>C</th> </tr> </thead> <tbody> <tr> <td>SR</td> <td>120</td> <td>43</td> </tr> </tbody> </table>	MODELS			∅ A	C	SR	120	43	Dimensions (mm)		
MODELS	∅ A	C										
SR	120	43										
	KIT SCB - Kit to convert C1.5 to built-in model KIT SCB5 - Kit to convert C5 0.5 to built-in model			22481 22483								
	<table border="1"> <thead> <tr> <th>MODELS</th> <th>∅ A</th> <th>B</th> <th>C</th> <th>D</th> </tr> </thead> <tbody> <tr> <td>SCB/SCB5</td> <td>142</td> <td>135</td> <td>59.5</td> <td>4.5</td> </tr> </tbody> </table>	MODELS			∅ A	B	C	D	SCB/SCB5	142	135	59.5
MODELS	∅ A	B	C	D								
SCB/SCB5	142	135	59.5	4.5								
MODELS	DESCRIPTION		CODE									
	C HCS Checks the relative humidity of the air: the extractor fan is activated automatically when the relative humidity percentage exceeds 65%. Otherwise, the appliance starts automatically a few seconds after the light is switched on and continues to run for a set time after it has been switched off again; this time period can be adjusted to a value between 3 and 20 minutes using a built-in trimmer.		12994									
	C TEMP Checks the temperature of the surrounding air: the extractor fan is activated automatically when a certain temperature is recorded; this can be adjusted, using an external trimmer, to a value between 10 °C and 40 °C above the set threshold. A timer keeps it running after the temperature has fallen below the set threshold, for a period of time which can be adjusted to a value between 3 and 20 minutes using a built-in trimmer.		12992									
	C SMOKE Checks the quality of the air when the air contains cigarette smoke, odours and other pollutants: the extractor fan is activated automatically when a concentration of odours higher than the set value is detected; this value can be adjusted using an external trimmer. A pre-set timer, which can be adjusted to a value between 3 and 20 minutes using a built-in trimmer, keeps the extractor fan running for the desired period of time.		12993									
	C PIR Checks for human motion in the room: the extractor fan is activated automatically for a specified time period, which can be adjusted between 3 and 20 minutes using a trimmer, when human movement is detected in its range.		12998									
	WWC TIMER Checks the operating time of the appliance to which it is connected: the extractor fan is activated automatically a few seconds after the light is switched on and continues to run for a set time, which can be adjusted to a value between 3 and 20 minutes using a built-in trimmer, after it has been switched off again.		12999									

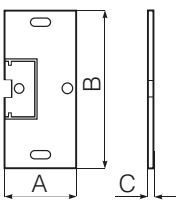

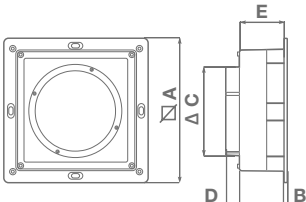



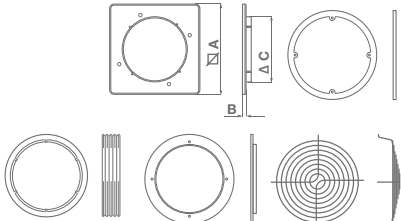

RESIDENTIAL VENTILATION

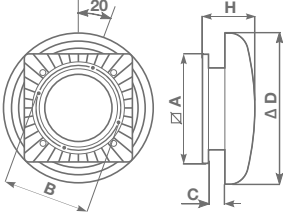
ACCESSORIES

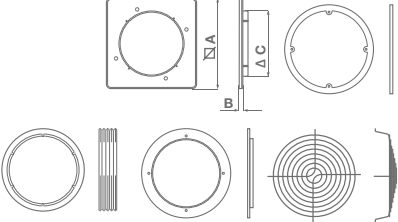
MODELS	DESCRIPTION							CODE	
	KIT TE - Roof cowl/wind baffle kit 150/6" - 230/9" - 300/12"								13001 13002 13003
	MODELS	CODE	∅ A	B	C	∅ D	H		
	150/6"	13001	215	175	28	300	111		
	230/9"	13002	294	249	30	400	145		
300/12"	13003	390	316	33	534	181			
Dimensions (mm)									
	KIT SO - Ceiling, false ceiling and panel kit 150/6" - 230/9" - 300/12"								13012 13014
	MODELS	CODE	∅ A	B	C				
	150/6"	13012	215	175	28				
	230/9"	13014	294	249	30				
Dimensions (mm)									
	KIT ML - Deep wall installation kit 150/6" - 230/9" - 300/12"								13015 13016 13017
	MODELS	CODE	∅ A	B	∅ C	D	H		
	KIT ML150/6"	13015	294	8	171	30	94		
	KIT ML 230/9"	13016	393	8	240	30	125		
KIT ML300/12"	13017	487	8	300	41	142			
Dimensions (mm)									
	KIT MU - Wall mounting kit with rods								13018
	MODELS	A	∅ B						
	KIT MU	380	M4						
Dimensions (mm)									
	KIT VV - Double opening window, secondary glazed kit KIT VV 150/6" - KIT VV 230/9" - KIT VV 300/12"								13021 13022 13023
	MODELS	CODE	∅ A	B	C				
	KIT VV 150/6"	13021	215	7	157				
	KIT VV 230/9"	13022	294	7	233				
KIT VV 300/12"	13023	390	7	303					
Dimensions (mm)									

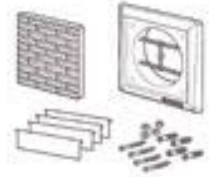
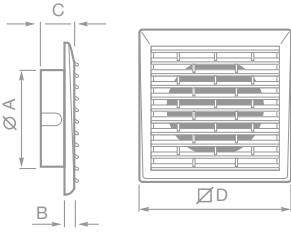

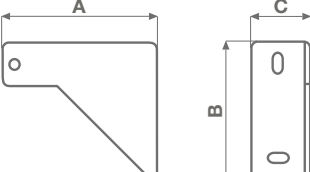
MODELS	DESCRIPTION		CODE																														
	KIT SA 230/9" - Darkroom cowl kit <table border="1"> <thead> <tr> <th>$\varnothing A$</th> <th>B</th> <th>C</th> <th>$\varnothing D$</th> <th>H</th> </tr> </thead> <tbody> <tr> <td>294</td> <td>249</td> <td>30</td> <td>400</td> <td>145</td> </tr> </tbody> </table> Dimensions (mm)		$\varnothing A$	B	C	$\varnothing D$	H	294	249	30	400	145	 13004																				
$\varnothing A$	B	C	$\varnothing D$	H																													
294	249	30	400	145																													
	KIT FF - Double opening window, secondary glazed kit KIT FF 150/6" - KIT FF 230/9" - KIT FF 300/12" <table border="1"> <thead> <tr> <th>MODELS</th> <th>CODE</th> <th>$\varnothing A$</th> <th>B</th> <th>C</th> </tr> </thead> <tbody> <tr> <td>KIT FF 150/6"</td> <td>13024</td> <td>215</td> <td>7</td> <td>157</td> </tr> <tr> <td>KIT FF 230/9"</td> <td>13025</td> <td>294</td> <td>7</td> <td>233</td> </tr> <tr> <td>KIT FF 300/12"</td> <td>13026</td> <td>390</td> <td>7</td> <td>303</td> </tr> </tbody> </table> Dimensions (mm)		MODELS	CODE	$\varnothing A$	B	C	KIT FF 150/6"	13024	215	7	157	KIT FF 230/9"	13025	294	7	233	KIT FF 300/12"	13026	390	7	303	 13024 13025 13026										
MODELS	CODE	$\varnothing A$	B	C																													
KIT FF 150/6"	13024	215	7	157																													
KIT FF 230/9"	13025	294	7	233																													
KIT FF 300/12"	13026	390	7	303																													
	KIT TC - Duct diameter for Spigot Plate <table border="1"> <thead> <tr> <th>MODELS</th> <th>CODE</th> <th>$\varnothing D$</th> </tr> </thead> <tbody> <tr> <td>KIT TC 150/6"</td> <td>13024</td> <td>215</td> </tr> <tr> <td>KIT TC 230/9"</td> <td>13025</td> <td>294</td> </tr> <tr> <td>KIT TC 300/12"</td> <td>13026</td> <td>390</td> </tr> </tbody> </table> Dimensions (mm)		MODELS	CODE	$\varnothing D$	KIT TC 150/6"	13024	215	KIT TC 230/9"	13025	294	KIT TC 300/12"	13026	390	 13027 13028 13029																		
MODELS	CODE	$\varnothing D$																															
KIT TC 150/6"	13024	215																															
KIT TC 230/9"	13025	294																															
KIT TC 300/12"	13026	390																															
	KIT MU Wall mounting kit with rods <table border="1"> <thead> <tr> <th>MODELS</th> <th>CODE</th> <th>$\varnothing A$</th> <th>B</th> <th>C</th> <th>$\varnothing D$</th> </tr> </thead> <tbody> <tr> <td>D 100</td> <td>22140</td> <td>99</td> <td>8</td> <td>20</td> <td>140</td> </tr> <tr> <td>D 125</td> <td>22141</td> <td>119</td> <td>8</td> <td>20</td> <td>160</td> </tr> <tr> <td>D 150</td> <td>22142</td> <td>155</td> <td>8</td> <td>20</td> <td>198</td> </tr> <tr> <td>D 90</td> <td>22143</td> <td>92.5</td> <td>8</td> <td>20</td> <td>140</td> </tr> </tbody> </table> Dimensions (mm)		MODELS	CODE	$\varnothing A$	B	C	$\varnothing D$	D 100	22140	99	8	20	140	D 125	22141	119	8	20	160	D 150	22142	155	8	20	198	D 90	22143	92.5	8	20	140	 22140 22141 22142 22143
MODELS	CODE	$\varnothing A$	B	C	$\varnothing D$																												
D 100	22140	99	8	20	140																												
D 125	22141	119	8	20	160																												
D 150	22142	155	8	20	198																												
D 90	22143	92.5	8	20	140																												
	CA-MU Galvanized sheet-metal brackets For wall or ceiling mounting <table border="1"> <thead> <tr> <th>A</th> <th>B</th> <th>C</th> </tr> </thead> <tbody> <tr> <td>144</td> <td>54</td> <td>55.8</td> </tr> </tbody> </table> Dimensions (mm)		A	B	C	144	54	55.8	 22674																								
A	B	C																															
144	54	55.8																															



RESIDENTIAL VENTILATION

ACCESSORIES

MODELS

DESCRIPTION

CODE

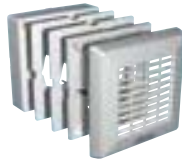

KIT TO WINDOW-MOUNT

Will allow any Vortice® Punto unit to be fitted to any single or double glazed window.
IPX4; Insulation: Cl.II; Weight Kg. 0.85/1.15/1.56.

MODELS	CODE	∅ A	B	C	∅ HOLE GLASS	THICKNESS MAX
F 100/4"	22131	158	69	22	123÷128	20
F 120/5"	22132	179	80	33	143÷148	20
F 150/6"	22133	213	87	40	178÷183	20

Dimensions (mm)

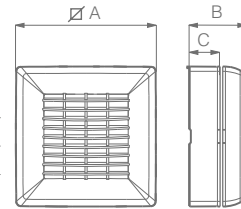

22131
22132
22133

RECESSED CEILING INSTALLATION KIT

MODELS	CODE	∅ H
MICRO	22491	268
MEDIO	22492	285
SUPER	22493	330

Dimensions (mm)

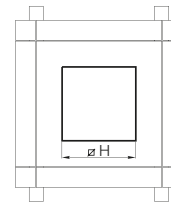

22491
22492
22493



RUBBER CEILING KIT

Made of soft rubber to prevent water infiltration and to maintain IPX4 protection on all surfaces.

MODELS	CODE	∅ A	B	C
S 100/4"	22154	166	99	10.5
S 120/5"	22155	187	119	10.5
S 150/6"	22156	222	156	10.5

Dimensions (mm)

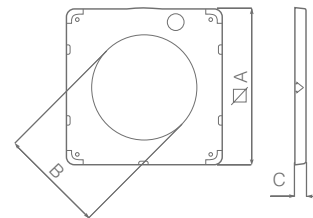

22154
22155
22156



LOFT MOUNTING BRACKETS

MODELS	CODE	A	B
D 90/100	22259	22.5	115
D 120	22260	22.5	135
D 150	22261	222	172

Dimensions (mm)

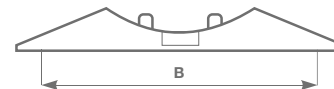

22259
22260
22261



TELESCOPIC WALL LINER





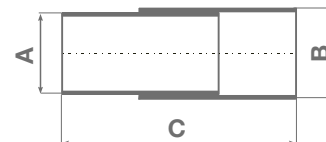



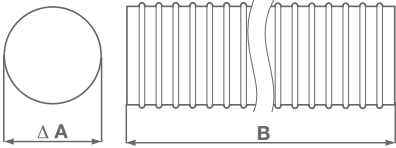

MODELS	CODE	A	B	C
D 100	22253	110	114	200-380
D 120	22254	130	135	200-380
D 150	22258	160	168	200-380

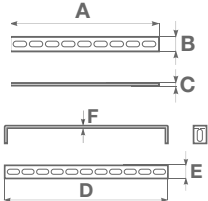
Dimensions (mm)

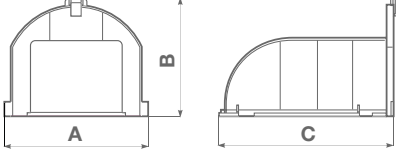

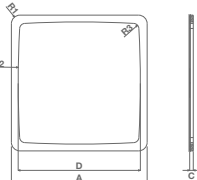
22256
22257
22258

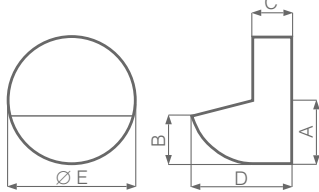

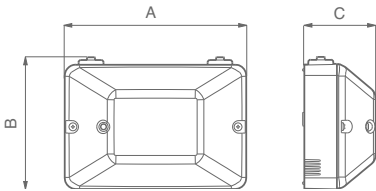
MODELS	DESCRIPTION		CODE								
	FLEXIBLE DUCT Flexible PVC duct (extendable up to 3 m)			22250 22251 22252							
	MODELS	CODE			Ø A	B					
	PVC Ø 100	22250			110	3000					
	PVC Ø 120	22251			130	3000					
PVC Ø 150	22252	160	3000								
Dimensions (mm)											
	FALSE CEILING KIT Kit for false ceiling installations (max. height 40 cm)			22815 22823							
	MODELS	CODE			A	B	C	D	E	F	
	VP-C	22815			275	20	3	324	20	3	
	Kit false ceiling	22823			275	20	3	226	20	3	
Dimensions (mm)											
	HORIZONTAL OUTLET SPIGOT For fitting to extractors to direct the outlet horizontally, 105x82 mm, white, plastic for Ariett I			22841							
	MODELS	A			B	C					
	Outlet spigot	105			82	175					
Dimensions (mm)											
	SF CEILING KIT			22162 22163 22164							
	MODELS	CODE			A	B	C	D	R1	R2	R3
	SF Ø 90-100	22162			171	171	5	150.5	7.5	1200	7
	SF Ø 120	22163			190	190	5	171	12	1400	7.5
SF Ø 150	22164	230	230	5	205.5	13	1700	5			
Dimensions (mm)											
	M 10/4 AIR FLOW DEFLECTOR For fitting to the delivery side of extractor fans to direct the air flow in any required direction within 360° Weight kg. 0.2. Design: F. Trabucco - M. Vecchi			22310							
	MODELS	A			B	C	D	E			
	M 10/4	49.5			37	30	77	99			
	Dimensions (mm)										
	GA 12V - Air flow deflector 220-240/12 V ~ 50 Hz; Weight Kg 0.8; Max °C 50; Insulation: Cl.II			22150 22151							
	MODELS	CODE			A	B	C				
	GA12V	22150			161	117	65				
	GA12V T	22823			161	117	65				
Dimensions (mm)											

Predstavništvo za Srbiju
AIRTREND Ltd.
Kumanovska 14
11000 Beograd, Srbija
Telefon +381 (0)11 383 6886, 308 5740
Telefax +381 (0)11 344 4113
E-mail gobrid@eunet.rs
www.airtrend.rs

Distribucija i prodaja
KOVENT
Kumanovska 14
Tel: 011 383 6886, 308 5740
Fax: 011 344 4113
E-mail office@kovent.rs
www.kovent.rs

